

TM 11-6625-320-12

DEPARTMENT OF THE ARMY TECHNICAL MANUAL

OPERATORS AND ORGANIZATIONAL
MAINTENANCE MANUAL

VOLTMETER, METER ME-30A/U
AND VOLTMETERS, ELECTRONIC
ME-30B/U AND ME-30C/U

This copy is a reprint which includes current
pages from Changes 1, 4 and 5.

HEADQUARTERS, DEPARTMENT OF THE ARMY
21 JUNE 1960

WARNING

Be careful when working on the 116- and 230-volt ac line connections. serious injury or death may result from contact with these terminals.

DON'T TAKE CHANCES!

RADIATION HAZARD

Tube type OB2WA, used in Voltmeter, Meter ME-30A/U, and Voltmeters, Electronic ME-30B/U and ME-30C/U, contains a small amount of radioactive material. This tube is potentially hazardous when broken. Contact qualified medical personnel immediately in case of an accidental cut. For further instructions, refer to TB SIG 226.

TECHNICAL MANUAL

Operator's and Organizational Maintenance Manual

VOLTMETER, METER ME-30A/U AND VOLTMETERS,
ELECTRONIC ME-30B/U AND ME-30C/U

TM 11-6625-320-12 }
CHANGES No. 1 }

HEADQUARTERS,
DEPARTMENT OF THE ARMY
WASHINGTON 26, D.C., 4 February 1963

TM 11-6625-320-12, 21 June 1960, is changed as follows:

Page 3, paragraph 1. Add paragraph 1.1 after paragraph 1.

1.1 Index of Publications
(Added)

Refer to the latest issue of DA Pam 310-4 to determine whether there are new editions, changes, or additional publications pertaining to your equipment. Department of the Army Pamphlet 310-4 is a current index of Technical Manuals, Technical Bulletins, Supply Bulletins, Lubrication Orders, and Modification Work Orders that are available through publications supply channels. The index lists the individual parts (-10, -20, -35P, etc.) and the latest changes to and revisions of each equipment publication.

Paragraph 2. Delete paragraph 2 and substitute:

2. Forms and Records
(Superseded)

a. *Report of Unsatisfactory Equipment.* Fill out DA Form 2407 (Maintenance Request) in accordance with instructions in TM 38-750 and forward it to: Commanding Officer, U.S. Army Electronics Materiel Support Agency, ATTN: SELMS-PIE, Fort Monmouth, N.J. The form should be filled out and forwarded to report-

- (1) Receipt of defective equipment (use DD Form 6 *b* below) if defect is due to damaged or improper shipment).
- (2) Equipment deficiencies (deadlined equipment).

(3) Equipment shortcomings (operable, but at less than rated capability or efficiency).

(4) Equipment improvement suggestions and recommendation.

b. *Report of Damaged or Improper Shipment.* Fill out and forward DD Form 6 (Report of Damaged or Improper Shipment), as prescribed in AR 700-58 (Army, NAVSANDA Publications 378, and AFR 71-4 (Air Force).

c. *Comments on Manual.* Forward all comments on this publication direct to: Commanding Officer, U.S. Army Electronics Materiel Support Agency, ATTN: SELMS-MP, Fort Monmouth, N.J. (DA Form 1598 (Record of Comments on Publications), DD Form 96 (Disposition Form), or letter may be used.)

Page 14. Delete paragraph 17 through 20 and substitute.

17. Scope of Operator's Maintenance
(Superseded)

The maintenance duties assigned to the operator are listed below, together with a reference to the paragraph covering the specific maintenance function. The duties assigned do not require special tools or test equipment.

a. Daily maintenance service and inspection (par. 19).

b. *Repairs.*

(1) Replacement of power indicator lamp (par. 21a).

(2) Replacement of fuse (par. 21b).

- (3) Tube testing and replacement (par 21c).
 - (4) Removal and replacement of panel-chassis (par. 21d).
- c. Cleaning (par. 20).

18. Operator's Preventive Maintenance
(Superseded)

Preventive maintenance is the systematic care, servicing, and inspection of equipment to prevent the occurrence of trouble, to reduce *downtime*, and to assure that the equipment is serviceable.

a. *Systematic Care.* The procedures given in paragraph 19 cover systematic care essential to proper upkeep of this equipment when it is used separately. When this equipment is used as part of a *set* or *system*, follow the procedures established in the *set* or *system* manual. If operated separately, the cleaning operations (par. 20) should be performed once each day that the equipment is used and, in any case, not less than once each week. All items should be checked before the equipment is placed in operation after a shutdown, during operation, or

after it is turned off, as specified in the applicable paragraph.

b. *Maintenance Service and Inspections.* The maintenance service and inspection chart (par. 19) outlines inspections to be made daily; however, if the equipment is used as part of a *set* or *system* manual. For equipment operated separately, these inspections are made to determine combat serviceability; that is, to determine that the equipment is in good general (physical) condition, in good operating condition, and likely to remain combat serviceable. To assist the operators in determining and maintaining combat serviceability, the chart indicates what to inspect, how to inspect, and what the normal conditions are; the *References* column lists the paragraph or other source that contains additional information pertaining to correction, if an abnormal conditions is observed. If the defect cannot be remedied by the operator, higher echelon maintenance or repair is required. Records and reports of these inspections must be made in accordance with TM 38-750.

19. Daily Maintenance Service and Inspection Chart
(Superseded)

Item No.	Procedures		References
	Item	Normal condition or result	
2	EXTERIOR: Inspect equipment for external cleanliness.	Equipment must be free of grease, dirt, rust, corrosion, and fungus.	Par 20.
5	POWER CABLE: Inspect power cable for breaks, cuts, kinks, strain, deterioration, and fraying.	Power cable must be in good condition	Higher echelon.
7	EXTERNAL HARDWARE: Inspect exterior hardware for looseness and binding.	a. Switches, binding posts, indicator light, carrying handle, and other hardware must be firmly secured. b. Switches must not bind.	
11	START: Operate ON-OFF switch to ON.	Red indicator lamp lights.	Par 21a and b.
12	METER MOVEMENT: With power on, measure a known voltage with range selector switch in proper position.	Meter will indicate correct voltage	Par 21c.
13	STOP: Operate ON-OFF switch to OFF.	Red indicator lamp goes out.	Higher echelon.

20. Cleaning
(Superseded)

Use the following procedure to clean the voltmeter.

a. Remove dust and loose dirt with a clean soft cloth.

Warning: Cleaning compound is flammable and its fumes are toxic. *Do not* use near a flame; provide adequate ventilation.

b. Remove grease, fungus, and ground-in dirt from the case; use it cloth damp (not wet) with Cleaning Compound (Federal stock No. 7930-395-9542).

c. Remove dust and dirt from the binding posts with a brush.

Caution: Do not press on the meter face (glass) when cleaning; the meter may become damaged.

d. Clean the front panel, the meter, and the switch knob; use a clean soft cloth. If difficulty in removing dirt occurs, dampen the cloth with water; mild soap may be used to make the cleaning more effective.

Page 16. Delete figure 7.

Page 17. Delete figure 8.

Page 20. Delete paragraphs 22 and 23 and substitute:

22. Scope of Organizational Maintenance (Superseded)

a. This chapter contains instructions covering second echelon maintenance of Voltmeter, Meter ME-30A/U and Voltmeters, Electronic ME-30B/U and ME-30C/U. It includes instructions for performing preventive maintenance services and repair functions to be accomplished by the organizational repairman. Operating instructions are in paragraphs 13 through 16.

b. Second echelon maintenance of the voltmeter includes—

- (1) Replacement of power indicator lamp (par. 21a).
- (2) Replacement of fuse (par. 21b).
- (3) Tube testing and replacement (par. 21c).
- (4) Removal and replacement of panel-chassis (par. 21d).
- (5) Cleaning (par. 20).
- (6) Preventive maintenance (pars. 23.1 and 23.2).
- (7) Painting (par. 23.3).

23. Organizational Preventive Maintenance (Superseded)

a. Preventive maintenance is the systematic care, inspection, and servicing of equipment to

maintain it in serviceable condition, prevent breakdowns and assure maximum operation capability. Preventive maintenance is the responsibility of all echelons concerned with the equipment and includes the inspection, testing, and repair or replacement of parts that inspection and tests indicate would fail before the next scheduled periodic service. Preventive maintenance service and inspections of the voltmeter at second echelon level are made at quarterly intervals, unless otherwise directed by the commanding officer. The maintenance services should be scheduled concurrently with the periodic service schedule of the carrying vehicle for all vehicular installations.

b. Maintenance forms and records to be used and maintained on this equipment are specified in TM 38-750. Paragraph 2 contains additional information concerning submission of specific forms.

c. The materials required are listed below:

- (1) Sandpaper.
- (2) Paint and brush.

23.1. Quarterly Maintenance (Added)

Quarterly maintenance on the voltmeter will be scheduled in accordance with the requirements in TM 38-750. If the equipment is part of a vehicular installation, the quarterly maintenance should be scheduled concurrently with the periodic service schedule of the carrying vehicle to reduce out-of-service time to a minimum. All deficiencies or shortcomings will be recorded, and those not corrected during the inspection and service will be immediately reported to higher echelon by use of forms and procedures specified by TM 38-750. Equipment that has a deficiency that cannot be corrected by second echelon should be deadlined in accordance with TM 38-750. Perform all the services listed in the quarterly maintenance service and inspection chart (par. 23.2), in the sequence listed. Whenever a *normal condition or result* is not observed, take corrective action in accordance with the *References* column.

23.2 Quarterly Maintenance Service and Inspection Chart
(Added)

Item No.	Procedures		References
	Item	Normal condition or result	
1	PREPARATION: See that the equipment is complete and properly installed.	a. Equipment must be complete..... b. Equipment must be properly installed.	a. TM 11-6625-320-12P. b. Par. 10.
2	EXTERIOR: Inspect equipment for external cleanliness and preservation.	a. Equipment must be free of grease, dirt, rust, corrosion, and fungus. b. Painted surfaces must be free of bare spots, rust, and corrosion.	a. Par. 20. b. Par. 23.3.
3	PUBLICATIONS: Check to see that pertinent publications are available.	a. Operator's and organizational maintenance manual must be complete and in usable condition, without missing pages. b. All changes pertinent to the equipment must be on hand.	b. DA Pam 310-4.
4	MODIFICATION WORK ORDERS: Check DA Pam 310-4 to determine if new applicable MWO's have been published.	ALL URGENT MWO's have been applied to the equipment. ALL ROUTINE MWO's have been scheduled.	Par. 1.1
5	POWER CABLE: Inspect power cable for breaks, cuts, kinks, strain, deterioration, and fraying.	Power cable must be in good condition	Higher echelon.
6	METER FACE: Inspect meter face for damaged housing and broken glass.	Meter face is in a condition suitable to protect the meter movement from physical damage, dust, and moisture.	Higher echelon.
7	EXTERNAL HARDWARE: Inspect exterior hardware for looseness and binding.	a. Switches, binding posts, indicator light, carrying handle, and other hardware must be firmly secured. b. Switches must not bind.	
8	INTERIOR: Inspect the interior of the equipment for damaged components, loose hardware, cleanliness, and moisture.	a. Resistors, capacitors, coils, wiring, and insulators must be free of burns, discoloration, cracks, chipping, and blistering. b. All hardware must be firmly seated and tightly secured.	a. Par. 21d.
9	FUSE: Check fuse for proper rating.....	Fuse must have proper rating.....	Par. 10c.
10	PLUCKOUT ITEMS: Inspect lamp, fuse, and tubes for proper seating.	All pluckout items must be firmly seated in their sockets.	Par. 21.
11	START: Operate ON-OFF switch to ON..	Red indicator lamp lights.....	Par. 21a and b.
12	METER MOVEMENT: With power on, measure a known voltage with range selector switch in proper position.	Meter will indicate correct voltage....	Par. 21c.
13	STOP: Operate ON-OFF switch to OFF..	Red indicator lamp goes out.	
14	SPARE PARTS: Check all spare parts (operator and organizational) for general condition and method of storage.	All spare parts must be in good condition and properly stored. There should be no evidence of overstock, and all shortages will be on valid requisitions.	TM 11-6625-320-12P.

23.3 Painting

Clean rust and corrosion from metal surfaces by lightly sanding the surfaces with fine sandpaper. Brush two thin coats of paint on the bare metal to protect it from further corrosion.

Refer to the applicable cleaning and refinishing practices specified in TM 9-2851.

Page 21. Delete figure 11.

Page 24, appendix. Delete the appendix and substitute:

APPENDIX (Superseded)

REFERENCES

Following is a list of applicable references available to the operator and organizational repairman.

- | | |
|--------------------|--|
| DA Pam 310-4 | Index of Technical Manuals, Technical Bulletins, Supply Bulletins, Lubrication Orders, and Modification Work Orders. |
| SB 38-100 | Preservation, Packaging, and Packing Materials, Supplies, and Equipment Used by the Army. |
| TB SIG 226 | Radioactive Electron Tube Handling. |
| TM 9-2851 | Painting Instructions for Field Use. |
| TM 11-6625-320-12P | Operator's and Organizational Maintenance Repair Parts and Special Tools Lists and Maintenance Allocation Chart: Voltmeter, Meter ME-30A/U, Voltmeter, Electronic ME-30B/U and ME-30C/U. |
| TM 38-760 | The Army Equipment Record System and Procedures. |

By Order of the Secretary of the Army:

EARLE G. WHEELER,
General, United States Army,
Chief of Staff.

Official:

J. C. LAMBERT,
Major General, United States Army,
The Adjutant General.

Distribution:

Active Army:

DASA (6)	OSA (1)
USASA (2)	AFIP (1)
CNGB (1)	AMS (1)
CofEngrs (1)	Army Pic Cen (2)
TSG (1)	USA Elct RD Actv (White Sands) (13)
CSigO (7)	USA Elct RD Actv (Ft Huachuca) (2)
CofT(1)	USA Strat Comm Comd (4)
USA CD Agcy (1)	USA Elct Mat Agcy (25)
USCONARC (5)	Chicago Proc Dist (1)
USA Mat Comd (5)	USARCARIB Sig Agcy (1)
ARADCOM (2)	Sig Fld Maint Shops (3)
ARADCOM Rgn (2)	USA Mob Spt Cen (6)
OS Maj Comd (3)	USA Corps (3)
OS Base Comd (2)	JBUSMC (2)
LOGCOMD (2)	Units org under fol TOE:
MDW (1)	5-15 (2)
Armies (2)	5-16 (2)
Corps (2)	5-45 (2)
Div (2)	5-46 (2)
1st FA Msl Bde (5)	5-600 (2)
Instl (2) except	5-605 (2)
Ft Monmouth (62)	6-545 (2)
USA Elct Comd (6)	6-615 (2)
USA Msl Comd (4)	6-619 (2)
USATC AD (2)	7-52 (2)
USATC Armor (2)	7-100 (2)
USATC Engr (2)	9-47 (2)
USATC FA (2)	9-67 (2)
USATC Inf (2)	9-217 (2)
USASTC (2)	9-227 (2)
Svc Colleges (2)	9-377 (2)
Br Svc Sch (2)	9-500 (AA-AC) (2)
except USASCS (100)	11-5 (2)
GENDEP (OS) (2)	11-6 (2)
Sig Sec, GENDEP (5)	11-7 (2)
Sig Dep (OS) (12)	11-6 (2)
Army Dep (2) except	11-15 (2)
Sacramento (17)	11-16 (2)
Tobyhanna (12)	11-26 (2)
Lexington (12)	11-27 (2)
Ft Worth (8)	11-36 (2)
Army Cml Cen (5)	11-39 (2)
USAPRDC (6)	11-55 (2)
USA Sig COMSEC Agcy (5)	11-56 (2)
White House Army Sig Agcy (5)	11-57 (2)
USAINTC (5)	11-58 (2)
WRAMC (1)	11-67 (2)
Trans Tml Comd (1)	11-68 (2)
Army Tml (1)	11-85 (2)
POE (1)	11-95 (2)

11-96 (2)
11-97(2)
11-98 (2)
11-117 (2)
11-155 (2)
11-156 (2)
11-157 (2)
11-158(2)
11-165 (2)
11-167 (2)
11-237 (2)
11-500 (AA-AE) (4)
11-555 (2)
11-557 (2)
11-558 (2)
11-587 (2)
11-592 (2)
11-597 (2)
11-608 (2)
29-1 (2)
29-27 (2)
29-26 (2)
29-35 (2)
29-36 (2)
29-51 (2)
29-55 (2)
29-56 (2)

29-65 (2)
29-307 (2)
32-56 (2)
32-57 (2)
32-67(2)
32-78 (2)
32-56(2)
33-500 (AA-AC) (2)
39-51 (2)
44-12 (2)
44-435 (2)
44-496(2)
44-437 (2)
44-445(2)
44-446 (2)
44-447 (2)
4-448(2)
44-535(2)
44-536(2)
44-537 (2)
44-544 (2)
44-545 (2)
44-546 (2)
44-547 (2)
44-548 (2)
57-100 (2)

NG: State AG (3) units same as active Army except allowance is one copy to each unit.

USAR: None.

Forexplanation of abbreviations used, see AR 320-50.

Changes in force: C1 and C4

TM 11-6625-320-12

*C 4

CHANGE }
No. 4 }

HEADQUARTERS
DEPARTMENT OF THE ARMY
WASHINGTON, D. C., 16 December 1966

Operator and Organizational Maintenance Manual

VOLTMETER, METER ME-30A/U AND VOLTMETERS,
ELECTRONIC ME-30B/U, ME-30C/U, AND ME-30E/U

TM 11-6625-320-12, 21 June 1960, is changed as follows:

Note. The parenthetical reference to a previous change (example: page 1 of C 2) indicates that pertinent material was published in that change.

The title of this manual is changed as shown above.

Page 9, section I. Delete paragraph 1 (page 1 of C 2) and substitute:

1. Scope

a. This manual describes Voltmeter, Meter ME-30A/U and Voltmeters, Electronic ME-30B/U, ME-30C/U, and ME-30E/U, and covers their installation, operation, and operator and organizational maintenance. It includes instructions for operation, cleaning, and inspection of the equipment, and replacement of parts available to operator and organizational maintenance personnel.

b. In this manual, when reference is made to all three models, the word voltmeter will be used. Thus, voltmeter represents Voltmeter, Meter ME-30A/U and Voltmeters, Electronic ME-30B/U, ME-30C/U, and ME-30E/U. Specific models will be referred to as ME-30A/U, ME-30B/U, ME-30C/U and ME-30E/U.

Paragraph 2 (page 1 of C 2). Delete and substitute:

2. Forms and Records

a. Reports of Maintenance and Unsatisfactory Equipment. Use equipment forms and records in accordance with instructions in TM 38-760.

b. Report of Damaged or Improper Shipment. Fill out and forward DD Form 6 (Report of Damaged or Improper Shipment) as prescribed in AR 700-58 (Army), NAVSANDA Publication 378 (Navy), and AFR 71-4 (Air Force).

c. Reporting of Equipment Publication Improvements. DA Form 2028 (Recommended Changes to DA Publications) will be used for reporting discrepancies and recommendations for improving this equipment publication. The form will be completed by the individual using the manual and forwarded direct to Commanding General, U.S. Army Electronics Command, ATTN: AMSEL-MR-NMP-AD, Fort Monmouth, N.J. 07703.

Page 24, Appendix (page 2 of C 2) Designated Appendix as Appendix A.

Delete the reference TM 11-6625-320-12P in its entirety.

(Page 1 of C 3) Change title of TB SIG 226 to read: "Identification and Handling of Radioactive Signal Items."

* This change supersedes C 2, 19 February 1965, and C 3, 11 May 1965.

Delete TM 9-2861 in its entirety and add the following:

SB 11-573 Painting and Preservation Supplies Available for Field Use for Electronics Command Equipment.

TB SIG 964 Field Instructions for Paint-

ing and Preserving Electronics Command Equipment.
 TM 9-219 Painting Instructions for Field Use.

(Page 2 of C 2) Add Appendixes B and C after Appendix A.

APPENDIX B BASIC ISSUE ITEMS

Section I. INTRODUCTION

B-1. General

This appendix lists items for Voltmeters, Electronic ME-30A/U, ME-30B/U, ME-30C/U and ME-30E/U, the component items comprising it, and the items which accompany it, or are required for installation, operation, or operator's maintenance.

B-2. Explanation of Columns

An explanation of the columns in section II is given below.

a. Source, Maintenance, and Recoverability Codes (Column 1).

(1) *Source code, column 1a.* The selection status and source for the listed item is noted here. The source code used is:

<i>Code</i>	<i>Explanation</i>
P	Applies to repair parts which are stocked in or supplied from the GSA/DSA, or Army supply system, and authorized for use at indicated maintenance categories.

(2) *Maintenance code, column 1b.* The lowest category of maintenance authorized to install the listed item is noted here. The maintenance code used is as follows:

<i>Code</i>	<i>Explanation</i>
C	Applies to repair parts authorized for local procurement. If not obtainable from local procurement, such repair parts will be requisitioned through normal supply channels with a supporting statement of nonavailability from local procurement.

(3) *Recoverability code, column 1c.* Not used.

Note. When no code is indicated in the recoverability column, the part will be considered expendable.

b. Federal Stock Number, Column 2. The Federal stock number for the item is indicated in this column.

c. Description, Column 3. The Federal item name, a five-digit manufacturer's code, a part number, and when required, the model designator (*), which indicates different models of the end equipment, are included in this column.

d. Unit of Issue, Column 4. The unit used as a basis of issue (e.g., ea, pr, ft, yd, etc.) is noted in this column.

e. Quantity Incorporated in Unit Pack, Column 5. Not used.

f. Quantity Incorporated in Unit, Column 6. The total quantity of the item used in the equipment is given in this column.

g. Quantity Authorized, Column 7. The total quantity of an item required to be on hand and necessary for the operation and maintenance of the equipment is given in this column.

h. Illustration, Column 8.

(1) *Figure number, column 8a.* Not used.

(2) *Item or symbol number, column 8b.*

This column lists the reference symbols used for identification of the items.

B-3. Federal Supply Codes

This paragraph lists the Federal supply code with the associated manufacturer's name.

<i>Code</i>	<i>Manufacturer</i>
81949-----	Military Specifications

SECTION II. BASIC ISSUE ITEMS LIST

(1) SOURCE CD	(2) MAINT. CD	(3) REC. CODE	BASIC ISSUE ITEMS LIST						(4) UNIT	(5) QTY INC IN UNIT	(6) QTY INC IN UNIT	(7) QTY AUTH	(8) ILLUSTRATIONS	
			(1) FEDERAL STOCK NUMBER	(2) DESCRIPTION	(3) MODEL	(4) UNIT	(5) QTY INC IN UNIT	(6) QTY INC IN UNIT					(7) QTY AUTH	(8) FIGURE NUMBER
			6625-643-1670	VOLTMETERS, ELECTRONIC ME-30A/U, ME-30B/U, ME-30C/U and ME-30E/U (This item is nonexpendable)					ea					
			ORD THRU AGC	NOTE: Model column 1 refers to ME-30A/U; column 2 refers to ME-30B/U; column 3 refers to ME-30C/U; column 4 refers to ME-30E/U.					ea	1	1			
				TECHNICAL MANUAL TM 11-6625-300-12					ea					
				NOTE: For technical manuals the quantity authorized indicates the number of copies packed with the equipment at the time of procurement. It represents the maximum quantity authorized. Where a number of these equipments are concentrated in a small area, the quantity on hand may be reduced to practical levels. Excess publications may be returned to publication supply centers through AG channels.										
P C			5960-262-3763	ELECTRON TUBE: 81349; 0B2VA					ea	1	1			V9
P C			5960-262-0151	ELECTRON TUBE: 81349; 6AU50T					ea	1	1			V7
P C			5960-188-0943	ELECTRON TUBE: 81349; 6AX50T					ea	1	1			V6
P C			5960-230-5307	ELECTRON TUBE: 81349; 6CB6					ea	1	1			V8
P C			5920-142-7383	FUSE, CARTRIDGE: 81349; F03G1R00A					ea	1	5			F1
P C			5920-284-9220	FUSE, CARTRIDGE: 81349; F03G1R00B					ea	1	5			F1
P C			5920-636-0963	FUSE, CARTRIDGE: 81349; F03G1R00B					ea	1	5			F1
P C			6240-155-8706	LAMP, INCANDESCENT: 81349; LM-52					ea	1	1			I1
P C			6240-155-8706	NO ACCESSORIES, TOOLS OR TEST EQUIPMENT ARE TO BE ISSUED WITH THIS EQUIPMENT. NO BASIC ISSUE ITEMS ARE MOUNTED IN OR ON THIS EQUIPMENT.					ea	1	1			DB1

FORM 481 (Replaces edition of 1 Dec 54, which is obsolete) NS-30A, B, C, E/U 4

APPENDIX C MAINTENANCE ALLOCATION

Section I. INTRODUCTION

C-1. General

This appendix provides a summary of the maintenance operations covered in the equipment literature for Voltmeters, Electronic ME-30A/U, ME-30B/U, ME-30C/U and ME-30E/U. It authorizes categories of maintenance for specific maintenance functions on repairable items and components and the tools and equipment required to perform each function. This appendix may be used as an aid in planning maintenance operations.

C-2. Explanation of Format for Maintenance Allocation Chart

a. Group Number. Not used.

b. Combat Assembly Nomenclature. This column lists the item names of component units, assemblies, subassemblies, and modules on which maintenance is authorized.

c. Maintenance Function. This column indicates the maintenance category at which performance of the specific maintenance function is authorized. Authorization to perform a function at any category also includes authorization to perform that function at higher categories. The codes used represent the various maintenance categories as follows:

<i>Codes</i>	<i>Maintenance category</i>
C-----	Operator/Crew
O-----	Organizational Maintenance

<i>Codes</i>	<i>Maintenance category</i>
F - - - -	Direct Support Maintenance
H - - - -	General Support Maintenance
D - - - -	Depot Maintenance

d. Tools and Equipment. The numbers appearing in this column refer to specific tools and equipment which are identified by these numbers in section III.

e. Remarks. Self-explanatory.

C-3. Explanation of Format for Tool and Test Equipment Requirements

The columns in the tool and test equipment requirements chart are as follows:

a. Tools and Equipment. The numbers in this column coincide with the numbers used in the tools and equipment column of the MAC. The numbers indicate the applicable tool for the maintenance function.

b. Maintenance Category. The codes in this column indicate the maintenance category normally allocated the facility.

c. Nomenclature. This column lists tools, test and maintenance equipment required to perform the maintenance functions.

d. Federal Stock Number. This column lists the Federal stock number.

e. Tool Number. Not used.

SECTION II. MAINTENANCE ALLOCATION CHART

MAINTENANCE ALLOCATION CHART															
GROUP NUMBER	COMPONENT ASSEMBLY NOMENCLATURE	MAINTENANCE FUNCTIONS										TOOLS AND EQUIPMENT	REMARKS		
		INSPECT	TEST	SERVICE	ADJUST	ALIGN	CALIBRATE	INSTALL	REPLACE	REPAIR	OVERHAUL			RESULT	
	VOLTMETERS, ELECTRONIC ME-30A/U, ME-30B/U, ME-30C/U AND ME-30E/U	0	0	0	0									Visual only 4,9,10 5,9,10 11	Replacement of easily replaced items-knobs, caps, lenses, etc
		0	0	0	0									11	
														10	
														1,2,3,5,6,7,8,10	
														D	

680-PH 1744

ME-30A,B,C,E/U 1

6831 (Supersedes edition of 1 Feb 54, which is obsolete)

ADDER, 48 P. Form 1 Jan 54

SECTION III. TOOL AND TEST EQUIPMENT REQUIREMENTS
TOOL AND TEST EQUIPMENT REQUIREMENTS

TOOLS AND EQUIPMENT	MAINTENANCE CATEGORY	NOMENCLATURE	FEDERAL STOCK NUMBER	TOOL NUMBER
1	H,D	MS-30A, B, C, E/U (continued)	6665-669-0266	
2	H,D	DECADE RESISTOR ZH-16/U	6625-624-3516	
3	H,D	GENERATOR, SIGNAL SG-299/U	6625-669-0747	
4	0	METER, TEST SET TS-682A/GSM-1	6625-581-2036	
5	H,D	MULTIMETER AM/UHM-105	6625-553-0142	
6	H,D	MULTIMETER TS-352B/U	6625-987-6603	
7	H,D	OSCILLOSCOPE AM/UHM-140C	6625-649-5193	
8	D	RADIOFREQUENCY, SIGNAL GENERATOR SET AM/UHM-25D	6625-699-0263	
9	O,H	TEST SET, ELECTRON TUBE TV-2/U	6625-820-006A	
10	H,D	TEST SET, ELECTRON TUBE TV-7D/U	5180-605-0079	
11	0	TOOL KIT, ELECTRONIC EQUIPMENT TK-100/G TOOL AND TEST EQUIPMENT AVAILABLE TO THE REPAIRMAN USER BECAUSE OF HIS ASSIGNED MISSION		

C-78 Plate

MS-30A, B, C, E/U

Form 6813 (Supersedes edition of 1 Jan 61, which is obsolete)

By Order of the Secretary of the Army:

HAROLD K. JOHNSON,
General, United States Army,
Chief of Staff.

Official:

KENNETH G. WICKHAM,
Major General, United States Army,
The Adjutant General.

Distribution:

Active Army:

USASA (2)	507th USASA Gp (5)
CNGB (1)	508th USASA Gp (5)
CC-E (7)	318th USASA Bn (5)
Dir of Trans (1)	318th USASA Bn (5)
CofEngrs (1)	177th USASA Co (5)
TSG (1)	182nd USASA Co (5)
CofSptS (1)	183rd USASA Co (5)
USAARENBD (2)	184th USASA Co (5)
USARADB (2)	266th USASA Co (5)
USAAESWBD (6)	1st USASA Fld Sta (5)
USACDCEA (1)	2nd USASA Fld Sta (5)
USACDCCBRA (1)	4th USASA Fld Sta (5)
USACDCCEA (1)	9th USASA Fld Sta (5)
USACDCCEA:	12th USASA Fld Sta (5)
Ft Huachuca (1)	13th USASA Fld Sta (5)
USACDCOA (1)	14th USASA Fld Sta (5)
USACDCQMA (1)	15th USASA Fld Sta (5)
USACDCTA (1)	102nd USASA Dot (5)
USACDCADA (1)	104th USASA Dot (5)
USACDCARMA (1)	52nd USASA Spec Opn Comd (5)
USACDCAVNA (1)	Svc Colleges (2)
USACDCARTYA (1)	USATC Armor (2)
USACDCSWA (1)	USATC Engr (2)
USAMC (6)	USATC Inf (2)
USCONARC (6)	USASTC (2)
ARADCOM (6)	WRAMC (1)
ARADCOM Rgn (2)	Army Pic Cen (2)
OS Maj Comd (4)	USACDCEC (10)
LOGCOMD (2)	Instl (2) except
USAMICOM (4)	Ft Hancock (4)
USASTRATCOM (4)	Ft Gordon (10)
USAESC (70)	Ft Huachuca (10)
MDW (1)	Ft Carson (26)
Armies (2) except	Ft Knox (12)
Fourth (6)	Ft Lee (6)
Seventh (6)	Ft Devens (5)
Eighth (6)	JCA, Ft Ritchie (6)
Corps (2)	WSMR (6)
USAC (3)	Gen Dep (2)
USASESCS (20)	Sig Sec Gen Dep (5)
USAADS (2)	Sig Dep (12)
USAAMS (6)	A Dep (2) except
USAARMS (5)	LBAD (14)
USAIS (5)	SAAD (30)
USAES (2)	TOAD (14)
USAOC&S (6)	LEAD (7)
USACSS (5)	SHAD (3)

NAAD (5)	11-557
SVAD (5)	11-558
CHAD (8)	11-587
ATAD (10)	11-592
GCAD (5)	11-597
ERAD (5)	11-608
PUAD (5)	17
Sig FLDMS (2)	17-100
AMS (1)	29-1
USAERDAA (2)	29-11
USAERDAW (12)	29-15
CRREL (2)	29-16
MAAG: Taiwan (5)	29-17
Detroit Arsenal (10)	29-21
Units org under fol TOE	29-25
(3 copies each):	29-27
1-907	29-28
5-900	29-28
5-905	29-27
6-615	29-55
6-616	29-56
7	29-75
7-100	29-79
9-87	29-105
9-277	29-109
11-5	29-207
11-6	31-105
11-8	32-52
11-25	32-56
11-56	32-57
11-57	32-67
11-58	32-68
11-68	32-77
11-95	32-78
11-97	32-500
11-98	32-56
11-117	32-500 (AA-AC)
11-155	37
11-156	37-100
11-157	39-51
11-158	44-235
11-215	44-236
11-237	44-568
11-247	55-458
11-500 (AA-AE, GL, GR, KA, KD, RL, RN, RO, RS)	57
11-555	57-100

NG: State AG (3); units—same as Active Army except allowance is one copy.

USAR: None.

For explanation of abbreviations used, see AR 320-50.

CHANGE }
No. 5 }

HEADQUARTERS
DEPARTMENT OF THE ARMY
WASHINGTON, D.C., 12 December /973

**Operator and Organizational
Maintenance Manual
VOLTMETER, METER ME-30A/U AND
VOLTMETERS, ELECTRONIC ME-30B/U,
ME-30C/U, AND ME-30E/U**

TM 11-6625-320-12, 21 June 1960, is changed as follows:

Page 3, paragraph 1.1. Delete paragraph 1.1 and substitute:

1.1. Indexes of Publications

a. *DA Pam 310-4*. Refer to the latest issue of DA Pam 310-4 to determine whether there are new editions, changes, or additional publications pertaining to the equipment.

b. *DA Pam 310-7*. Refer to DA Pam 310-7 to determine whether there are modification work orders (MWO's) pertaining to the equipment.

Paragraph 2. Delete paragraph 2 and substitute:

2. Forms and Records

a. *Reports of Maintenance and Unsatisfactory Equipment*. Maintenance forms, records, and reports which are to be used by maintenance personnel at all maintenance levels are listed in prescribed by TM 38-750.

b. *Report of Packaging and Handling Deficiencies*. Fill out and forward DD Form 6 (Report of Packaging and Handling Deficiencies) as prescribed in AT 700-58 (Army)/NAVSUP PUB 378 (Navy)/AFR 71-4 (Air Force)/and

MCO P4030.29 (Marine Corps).

c. *Discrepancy in Shipment Report (DISREP) (SF 361)*. Fill out and forward Discrepancy in Shipment Report (DISREP) (SF 361) as prescribed in AR 55-38 (Army)/NAVSUP PUB 459 (Navy)/AFM 75-34 (Air Force)/and MCO P4610.19 (Marine Corps).

2.1 Reporting of Errors

The reporting of errors, omissions, and recommendations for improving this publication by the individual user is encouraged. Reports should be submitted on DA Form 2028, Recommended Changes to Publications, and forwarded direct to Commander, US Army Electronics Command, ATTN: AMSEL-MA-C, Fort Monmouth; NJ 07703.

Page 5. After paragraph 5 add:

5.1. Items Comprising an Operable Equipment

Electronic Voltmeters ME-30A/U, ME-30B/U, ME-30C/U, and ME-30E/U (FSN 6625-643-1670) each comprise an operable end item.

Page 24, appendix B. Delete appendix B.

By Order of the Secretary of the Army:

CREIGTON W. ABRAMS
General, United States Army,
Chief of Staff

Official:

VERNE L. BOWERS
Major General, United States Army
The Adjutant General.

Distribution:

Active Army

USASA (2)
CNGB (1)
ACSC-E (2)
Dir of Trans (1)
COE (1)
TSG (1)
USAARENBD (1)
USAMB (10)
AMC (1)
TRADOC (2)
ARADCOM (2)
ARADCOM Rgn (2)
OS Maj Comd (4)
USASAE (2)
USASA (Pac) (2)
LOGCOMDS (3)
MICOM (2)
TECOM (2)
USACC (4)
MDW (1)
Armies (2)
Corps (2)
HISA (ECOM) (21)
Svc Colleges (1)
USASESS (20)
USAADS (2)
USAFAS (2)
USAARMS (2)
USAIS (2)
USAES (2)
USAINTS (3)
WRAMC (1)
USACDCEC (10)
ATS (1)
USACSS (5)
MAAG (1)
USARMIS (1)
Instl (2) except
 Fort Gordon (10)
 Fort Huachuca (10)
 WSMR (1)
 Fort Carson (10)
 Ft Richardson (ECOM Ofc) (2)
Army Dep (2) except
 LBAD (14)
 SAAD (30)
 TOAD (14)
 ATAD (10)
USA Dep (2)
Sig Sec USA Dep (5)
Sig Dep (5)
Sig FLDMS (1)

USAERDAA (1)
USAERDAW (1)
Units org under fol TOE:

(1 copy each unit)

6-615
6-616
7
7-100
11-35
11-96
11-97
11-98
11-117
11-215
11-237
11-247
11-500(AA-AC)
17
17-100
29-1
29-11
29-15
29-16
29-17
29-21
29-27
29-35
29-36
29-37
29-55
29-56
29-75
29-79
29-106
29-108
29-134
29-136
29-307
31-106
32-52
32-56
32-67
32-67
32-77
32-78
32-800
32-500
(AA-AC)
37
37-100
37-51
44-236
44-236
44-548
55-458
57
57-100
NG: State AG (3)
USA: None

For explanation of abbreviations used, see AR 310-50.

TECHNICAL MANUAL }
 No. 11-6625-320-12 }

HEADQUARTERS,
 DEPARTMENT OF THE ARMY
 WASHINGTON 25, D. C., 21 June 1960

**VOLTMETER, METER ME-30A/U AND
 VOLTMETERS, ELECTRONIC ME-30B/U AND ME-30C/U**

		Paragraph	Page
CHAPTER	1.	INTRODUCTION	
Section	I.	General	
		Scope	1 3
		Forms and records	2 3
	II.	Description and data	
		Purpose and use.	3 3
		Technical characteristics	4 3
		Table of components.	5 5
		Description of voltmeter	6 5
		Differences in models.	7 5
		Additional equipment required	8 5
CHAPTER	2.	SERVICE UPON RECEIPT OF EQUIPMENT	
		Unpacking	9 7
		Checking unpacked equipment	10 7
CHAPTER	3.	OPERATING INSTRUCTIONS	
Section	I.	Operator's controls and indicators	
		Operating controls, indicators, and binding posts	11 9
		Voltmeter ranges	12 9
	II.	Operation	
		General	13 9
		Voltage measurements	14 10
		Decibel measurements	15 10
		Amplifier operation	16 12
CHAPTER	4.	OPERATOR'S MAINTENANCE INSTRUCTIONS	
		Scope of operator's maintenance	17 14
		Preventive maintenance	18 14
		Visual inspection	19 14
		Operational checklist.	20 14
		Repairs	21 15
CHAPTER	5.	ORGANIZATIONAL MAINTENANCE	
		Scope of organizational maintenance	22 20
		Organizational preventive maintenance	23 20
CHAPTER	6.	SHIPMENT, LIMITED STORAGE AND DEMOLITION TO PREVENT ENEMY USE	
Section	I.	Shipment and limited storage	
		Removal from service	24 22
		Repackaging for shipment or limited storage	25 22
	II.	Demolition of materiel to prevent enemy use	
		Authority for demolition.	26 23
		Methods of destruction	27 23
APPENDIX		REFERENCES	24
GLOSSARY		25

*This manual supersedes so much of TM 11-5132, 16 October 1957; C1, 8 April 1958; C2, 26 August 1958; C3, 9 January 1959; and C4, 10 December 1959; as is applicable to operation and organizational maintenance of the equipment.

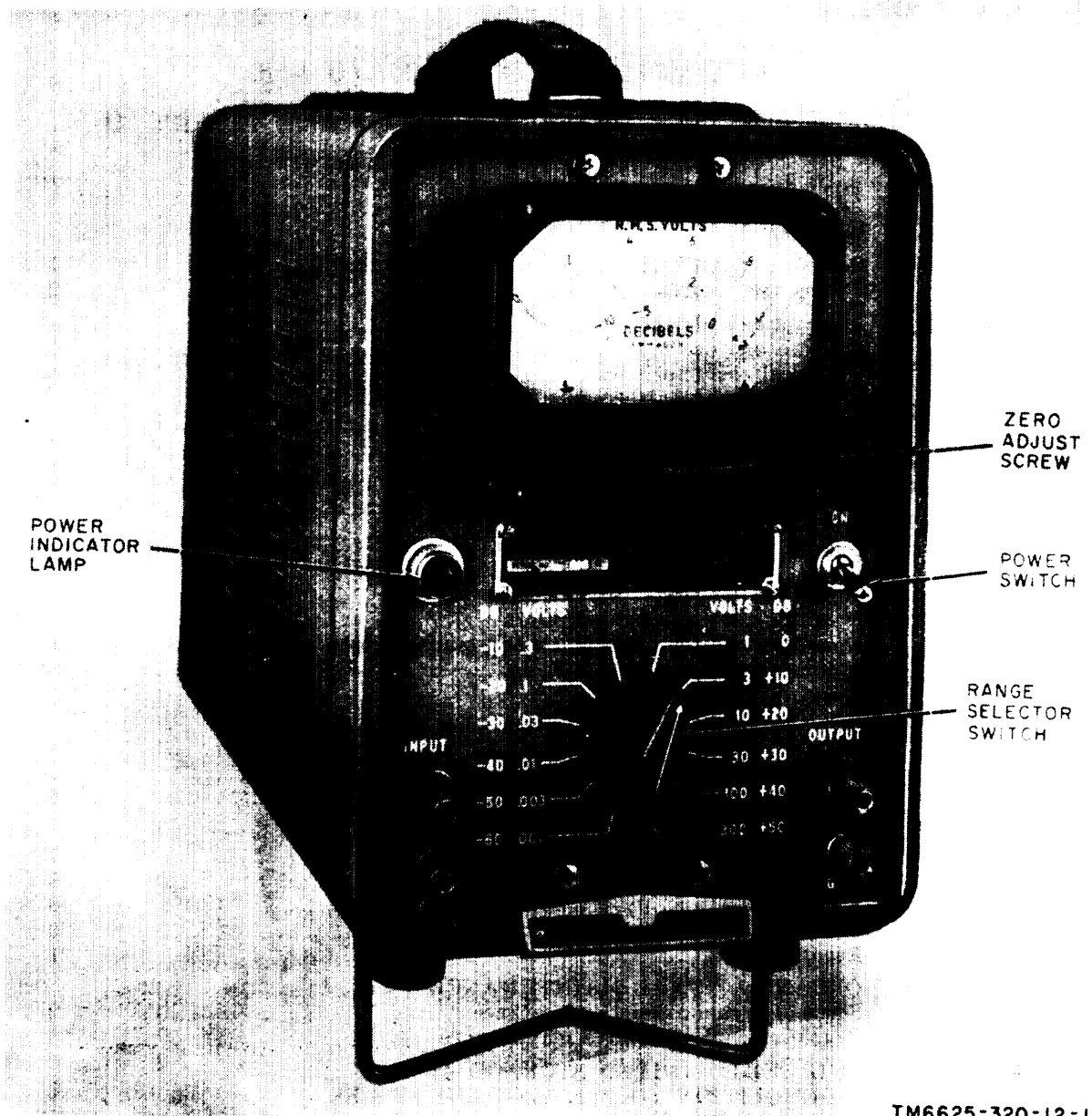

Figure 1. Voltmeter, Meter ME-30A/U, less spares.

CHAPTER 1

INTRODUCTION

Section I. GENERAL

1. Scope

a. This manual describes Voltmeter, Meter ME-30A/U and Voltmeters, Electronic ME 30B/U and ME-30C/U and covers their installation, operation, and first and second echelon maintenance. It includes instructions for operation, cleaning, and inspection of the equipment, and replacement of parts available to first and second echelon maintenance personnel. The maintenance allocation chart for this equipment is published in TM 11-6625-320-12P.

b. In this manual, when reference is made to all three models, the word voltmeter will be used. Thus, voltmeter represents Voltmeter, Meter ME-30A/U and Voltmeters, Electronic ME-30B/U and ME-30C/U. Specific models will be referred to as ME-30A/U, ME-30B/U, and ME-30C/U.

2. Forms and Records

a. *Unsatisfactory Equipment Report.* Fill out and forward DA Form 468 (Unsatisfactory Equipment Report), to Commanding Officer, U. S. Army Signal Equipment Support Agency, Fort Monmouth, N. J., as prescribed in AR 70038.

b. *Report of Damaged or Improper Shipment.* Fill out and forward DD Form 6 (Report of Damaged or Improper Shipment) as prescribed in AR 700-58.

c. *Preventive Maintenance Forms.* Prepare DA Form 11-266 (fig. 7, 8, and 11) (Maintenance Check List for Signal Equipment (Test Equipment)), in accordance with instructions on the form.

d. *Comments on Manual.* Forward all other comments on this publication directly to the Commanding Officer, U. S. Army Signal Publications Agency, Fort Monmouth, N. J.

Section II. DESCRIPTION AND DATA

3. Purpose and Use

a. The voltmeters are a vacuum-tube type. The voltage scale of each is calibrated in terms of the root-mean-square (rms) voltage of a sine wave. Each is capable of measuring alternating current (ac) voltages from 0.001 volt full scale to 300 volts full scale through a frequency range of 10 cycles per second (cps) to 4 megacycles per second (mcs).

b. The voltmeters are used for measuring ac voltages, gain, audiofrequency (af) and radiofrequency (rf) levels, and hum and noise levels. The scales of the meters permit measurements to be expressed either in decibels per milliwatt (dbm) or in decibels (db). The voltmeter may also be used as high gain, broadband amplifiers to provide greater sensitivity to other equipment such as oscilloscopes and bridges.

4. Technical Characteristics

Ranges:

volts, full scale 001, .003, .01, .03, .1, .3, 1, 3, 10, 30, 100, 300 volts ac, rms.

Decibels with respect to 0-db point -60, -50, -40, -30, -20, -10, 0, +10, +20, +30, +40, +50 db.

Meter type Dc milliammeter; calibrated to indicate rms value of sine-wave voltage. Full scale deflection at 1 ma.

Meter scale calibrations:

Voltage scales 0 to 1.0 and 0 to 3.

Decibel scale -12 to +2 dbm: zero level, 1 milliwatt in 600 ohms.

Frequency range 10 cps to 4 mcs.

Accuracy, all ranges:

20 cps to 1 mcs 2 percent of full scale value.

20 cps to 2 mcs 3 percent of full scale value.

10 cps to 4 mcs 5 percent of full scale value.

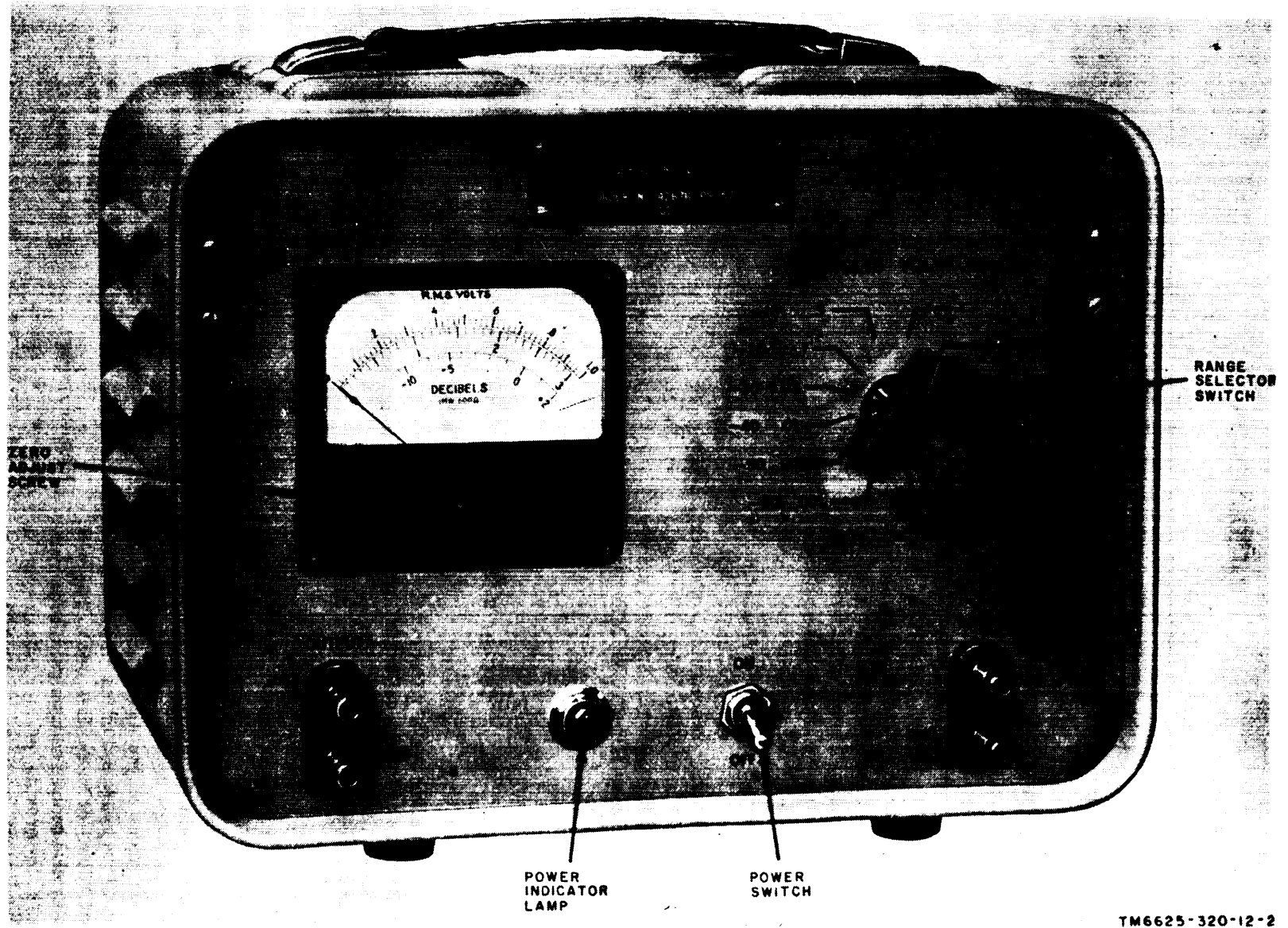

Figure 2. Voltmeter, Electronic ME-30B-U, less spares.

TM6625-320-12-2

Input impedance:

0.001-volt to 0.3-volt 10 megohms shunted by 24 ranges uuf.

1-volt to 300-volt 10 megohms shunted by 14 ranges uuf.

Power input requirements 115 volts (± 10 percent) or 230 volts (± 10 percent), 50 to 1,000 cps.

Power consumption70 watts (approximately).

Amplifier output circuit:

Open circuit output 50 ohms. impedance

Open circuit voltage, 0.15 volt, rms.

full-scale

deflection

5. Table of Components

a. Component. Any one of the models, listed in the table below, together with a set of running spares (*b* below) and 2 copies of TM 11-6625-320-12, makes up a single complete unit.

Voltmeter	Fig.	Height (in.)	Depth (in.)	Width (in.)	Unit weight (lb)
ME 30A U	1	11 $\frac{1}{4}$	11 $\frac{3}{4}$	7 $\frac{1}{4}$	18
ME 30B U	2	8 $\frac{1}{4}$	8	12	18
ME 30C U	1	11 $\frac{1}{4}$	11 $\frac{3}{4}$	7 $\frac{1}{4}$	18

b. Running Spares (fig. 3).

Quantity	Item	Reference designation
1	Electron tube, OB2WA (para 21 c (4))	V9
2	Electron tube, 6CB6	V8
1	Electron tube, 6AU5GT	V7
1	Electron tube, 6AX5GT	V6
3	Fuse, 1 ampere (para 21 b)	F1
1	Lamp LM-52	DS-1

6. Description of Voltmeter

(fig. 1 and 2)

The voltmeter consists of a removable panel-chassis assembly contained in a louvered case. A carrying handle is fastened to the top of the case. The front panel contains the operating controls, binding posts, indicator lamp, and the meter. The fuseholder, containing the fuse for the power supply input circuit, and the power cable are located at the rear of the panel-chassis assembly (fig. 9).

7. Differences in Models

The ME-30A/U, ME-30B/U, and ME-30C/U are similar in purpose and operation. The differences between models are shown below.

Item	ME 30A U	ME-30B U	ME 30C U
Physical appearance (para 5 d)	Narrow and high	Wide and low	Narrow and high.
INPUT binding posts	Left side	Right side	Left side.
OUTPUT binding posts	Right side	Left side	Right side.
Ground panel marking on terminals	G	GND	G.
Power switch position panel marking	ON	ON-OFF	ON.
Meter casing shape	Rectangular	Rectangular	Round.
Tube location	B, Fig. 10	A, Fig. 10	B, Fig. 10.
Front panel controls and indicators locations.	Fig. 1	Fig. 2	Fig. 1.

8. Additional Equipment Required

Test leads are required, but not supplied with the voltmeter. The INPUT and OUTPUT binding posts will accommodate test leads with the insulation stripped from the ends, or leads ter-

minated with single banana plugs, such as the type bearing Federal stock No. 5935-405-0338. Each pair of binding posts is arranged so that test leads terminated in a double banana plug with $\frac{3}{4}$ -inch spacing may also be used.

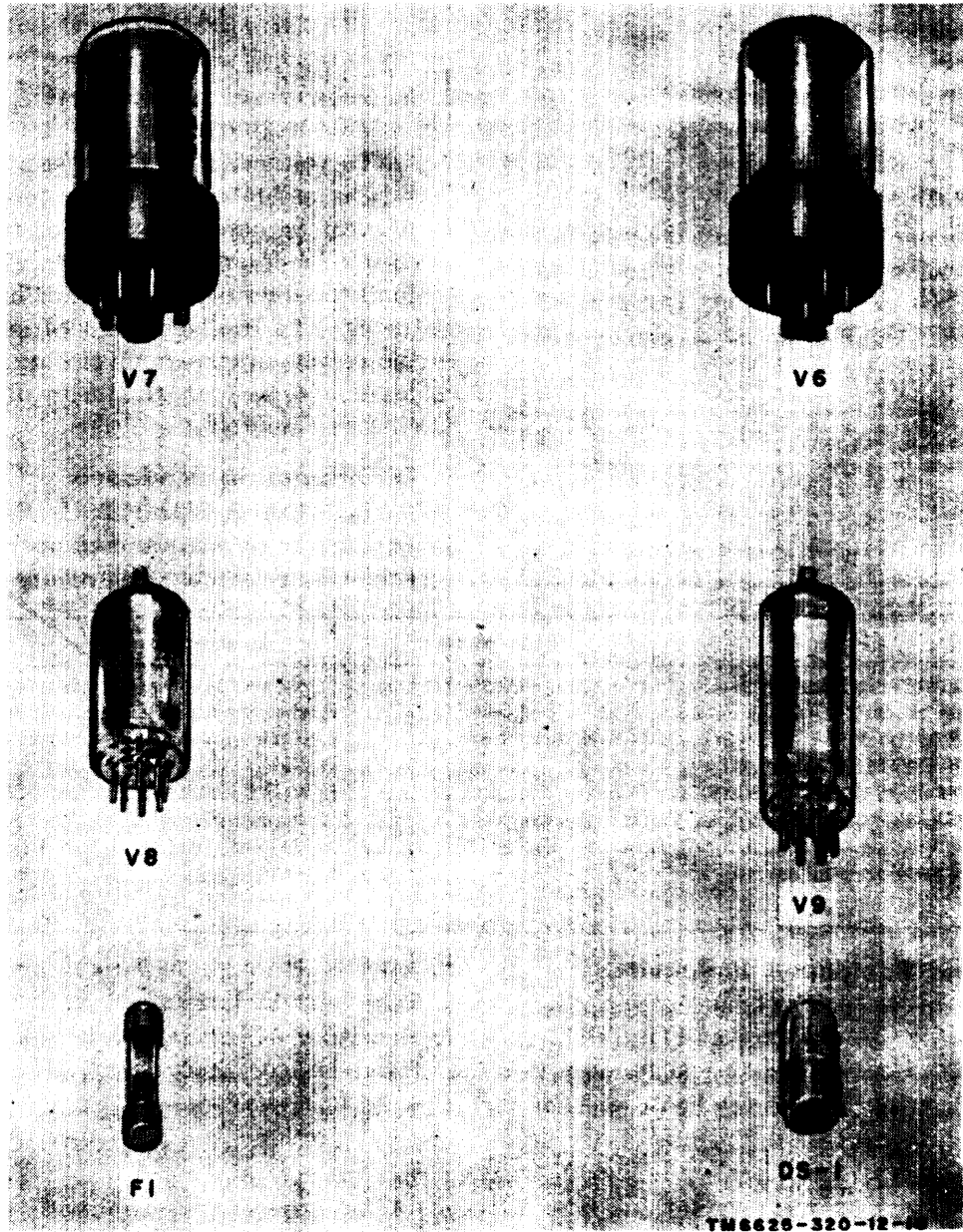

Figure 3. Running spares.

CHAPTER 2

SERVICE UPON RECEIPT OF EQUIPMENT

9. Unpacking

a. Packaging Data (fig. 4).

- (1) When packaged and packed for over-sea shipment, the voltmeters are packed in multiples of four in a nailed wooden box. Each voltmeter is further protected by separate packaging in a fiberboard box. The spare parts are placed in a separate fiberboard carton which is placed in the fiberboard box containing the voltmeter. Both voltmeter and spare parts carton are placed in a vaporproof barrier, desiccated and placed in a water-resistant fiberboard carton. The cartons are placed four each in a nailed wooden box. The dimensions and contents of a typical shipping box are:

Box No.	Voltmeter type No.	Outside dimensions			Volume (cu ft)	Packed wt (lb)
		L (in.)	W (in.)	D (in.)		
1	ME-30A/U	34 3/4	20 3/4	13 3/4	6.9	140
1	ME-30B/U	27 3/4	20 3/4	13	5.5	136
1	ME-30C/U	34 3/4	20 3/4	13 3/4	6.9	140

Based on four voltmeters in one wooden box.

- (2) When packaged and packed for domestic shipment, the methods applied may vary depending on the supply source. The shipping container may be in the form of a fiberboard box.
- b. *Removing Contents.* Be careful in unpacking and unpacking. Do not thrust tools into the interior of any container or wrap. For removal, select a site free from dust, dirt, and excessive moisture.

- (1) *Unpacking (when received overseas).* Cut the steel straps just below the box cover. Remove the nails from the top, side, and end with a nailpuller and remove the wooden top, side, and end.
- (2) *Unpacking (when received overseas).* Remove the fiberboard container. Cut through the moisture-vaporproof barrier. Cut through the

three edges of the inner container. Remove the contents.

- (3) *Unpacking (when received in CONUS).* Follow applicable procedure as specified in (2) above.

10. Checking Unpacked Equipment

a. Inspect the equipment for damage incurred during shipment. If the equipment has been damaged, refer to paragraph 2.

b. Check the equipment against the packing list. When no packing list accompanies the equipment, use the table of components (para 5).

c. To prepare the equipment for use, proceed as follows:

- (1) Check the fuse and the power indicator lamp (para 21).

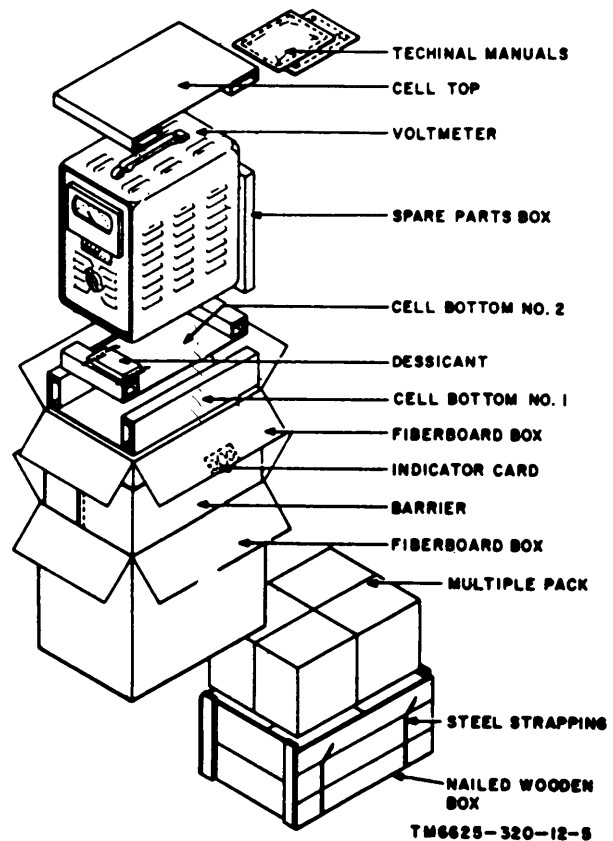

Figure 4. Packaging diagram.

- (2) Check to see that the transformer primary terminal strapping is connected for the power source to be used in accordance with the table below. Removal and replacement of the chassis is described in paragraph 21d.

Ac power source (volts)	Fuse rating		ME-300/U and ME-30C/U terminal strapping (C and D, Fig. 5)		ME-30A/U terminal strapping (A and B, Fig. 5)	
	Amp	Volts	From	To	From	To
115	1	250	10	12	2	4
			11	13	6	8
230	0.5	250	11	12	4	6

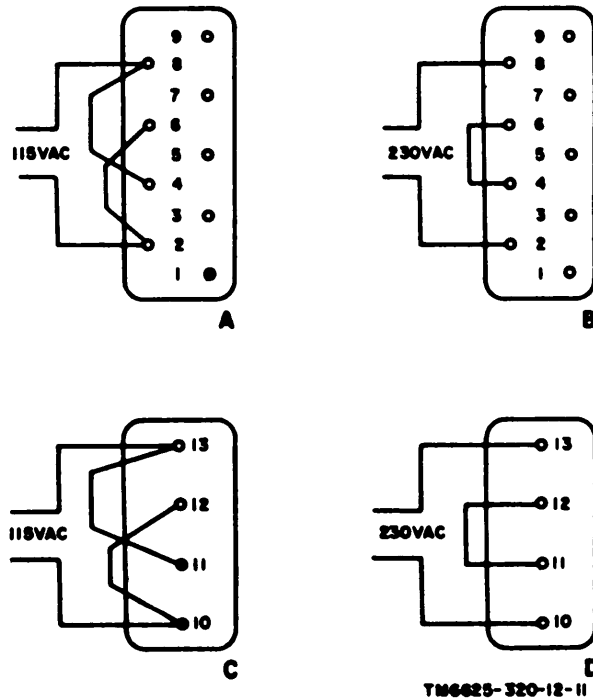

Figure 5. Power transformer primary strapping diagram.

CHAPTER 3 OPERATING INSTRUCTIONS

Section I. OPERATOR'S CONTROLS AND INDICATORS

Caution. The voltage applied to the INPUT binding posts of the voltmeter *must not exceed 600 volts*. Higher voltages will break down the capacitors in the input circuit.

11. Operating Controls, Indicators, and Binding Posts (fig. 1 and 2)

Control, indicator, or binding posts	Description and function						
Range selector switch....	A 12-position rotary switch—selects all internal connections for the 12 voltage and decibel ranges.						
Power switch.....	A 2-position toggle switch: <table style="margin-left: 20px; border-collapse: collapse;"> <tr> <td style="text-align: center; padding-right: 10px;"><i>Position</i></td> <td style="text-align: center;"><i>Function</i></td> </tr> <tr> <td style="text-align: center;">ON</td> <td>Turns the voltmeter on.</td> </tr> <tr> <td style="text-align: center;">OFF^a</td> <td>Turns the voltmeter off.</td> </tr> </table>	<i>Position</i>	<i>Function</i>	ON	Turns the voltmeter on.	OFF ^a	Turns the voltmeter off.
<i>Position</i>	<i>Function</i>						
ON	Turns the voltmeter on.						
OFF ^a	Turns the voltmeter off.						
Zero adjust screw	A screwdriver adjustment—adjusts the meter pointer to zero on the voltage scales.						
Power indicator lamp....	A red indicator lamp—lights when the power switch is operated to the ON position.						
Meter.....	A dc milliammeter—provides an indication of the voltage or db level of the signal under test.						
INPUT binding posts ^b	For connection of signal to be measured or amplified. GND binding post is the connection to chassis ground of the voltmeter.						

Control, indicator, or binding posts	Description and function
OUTPUT binding posts ^b	For connection to the output of the internal amplifier. GND binding post is the connection to chassis ground of the voltmeter.

^aThe off position is not panel marked on the ME-30A/U and the ME-30C/U.
^bThe ground binding post is marked G on the ME-30A/U and the ME-30C/U.

12. Voltmeter Ranges (fig. 1 and 2)

The following chart provides a comparison of the relationship between the position of the range selector switch and the voltage and decibel ranges of the voltmeter:

Range selector switch position		Range of measurement (volts)	Range of measurement (db)
VOLTS	DB		
.001	-60	0 to 0.001	-72 to -58
.003	-50	0 to 0.003	-62 to -48
.01	-40	0 to 0.01	-52 to -38
.03	-30	0 to 0.03	-42 to -28
.1	-20	0 to 0.1	-32 to -18
.3	-10	0 to 0.3	-22 to -8
1	0	0 to 1	-12 to +2
3	+10	0 to 3	-2 to +12
10	+20	0 to 10	+8 to +22
30	+30	0 to 30	+18 to +32
100	+40	0 to 100	+28 to +42
300	+50	0 to 300	+38 to +52

Section II. OPERATION

13. General

a. Meter Characteristics.

- (1) Before power is applied to the instrument, the meter pointer must point exactly to zero (on the voltage scales). If it does not point to zero, adjust the zero adjust screw (fig. 1 and 2) until it does. The adjustment is made properly only when the movement of the meter needle is in a direction opposite to the rotation of the zero adjust screw. If it is necessary to

reposition the meter needle after use, wait at least 15 minutes after disconnecting the power before making the meter zero adjustment.

- (2) After the voltmeter is turned on, there may be a meter indication of as much as two scale divisions. This effect is normal and does not affect the accuracy of the instrument.

b. Effect from Stray Voltages.

- (1) When the voltmeter is used on any one of the three lowest ranges, the

meter pointer may deflect full scale or beyond before voltage is applied to the input circuit. This condition is normal and is caused by pickup from stray voltages in the vicinity of the instrument. The accuracy of the meter indication is not affected unless the voltage under measurement is from a high impedance source. For maximum accuracy on the .001 VOLTS range, the voltage under measurement should be applied to the voltmeter through a coaxial type cable.

- (2) When the voltage under measurement is from a high impedance source, hum pickup may affect the meter indication because of the high impedance of both the source and the voltmeter. Shielded test leads will reduce such pickup but will cause an increase in the capacity shunted across the source, with the possibility of excessive circuit loading,

c. Effect from Harmonics. Inaccurate measurements may result when the voltage under measurement contains harmonics. This is due to the current through the meter being proportional to the average value of the measured ac voltage and also due to the meter being calibrated in terms of rms voltage of a sine wave. The chart below illustrates the deviation of the meter indication from the true rms value when the input voltages contain harmonics.

Input voltage characteristics (voltage and harmonic content)	True rms value (volts)	Meter indication (volts)
Fundamental (100 volts)	100	100
Fundamental +10 percent 2d harmonic.	100.5	100
Fundamental +20 percent 2d harmonic.	102	100 to 102
Fundamental +50 percent 2d harmonic.	112	100 to 110
Fundamental +10 percent 3d harmonic.	100.5	96 to 104
Fundamental +20 percent 3d harmonic.	102	94 to 108
Fundamental +50 percent 3d harmonic.	112	90 to 116

Note. This chart is universal in application since these are inherent in all average-reading type voltage-measuring instruments.

14. Voltage Measurements

(fig. 1 and 2)

The two upper meter scales (R.M.S. VOLTS) are provided for voltage measurements. When the range selector switch is set at the .001, .01, .1, 1, 10, or 100 VOLTS position, read the indication on the 0 to 1.0 scale. When the range selector switch is set at the 003, .03, .3, 3, 30, or 300 VOLTS position, read the indication on the 0 to 3 scale.

a. Check to see that the meter pointer indicates exactly 0 on the voltage scales (para. 13a(1)).

b. Connect the voltmeter to the ac power source (para 10c(2)).

c. Operate the power switch to the ON position, and allow a warmup period of approximately 5 minutes.

d. Operate the range selector switch to the desired position (para 12).

e. Connect the voltage to be measured to the INPUT binding posts.

f. Note the meter indication on the applicable R.M.S. VOLTS scale.

g. To obtain the value of the voltage being measured, multiply the meter reading by a factor which corresponds to the range being used. The meter reading will be a value between 0 and 1 or a value between 0 and 3. The correct multiplying factor may be located in the table below.

Range selector switch setting (VOLTS)	Read on scale between	Multiply reading by
.001	0 to 1.0	0.001
.003	0 to 3	0.001
.01	0 to 1.0	0.01
.03	0 to 3	0.01
.1	0 to 1.0	0.1
.3	0 and 3	0.1
1	0 and 1.0	1
3	0 and 3	1
10	0 and 1.0	10
30	0 and 3	10
100	0 and 1.0	100
300	0 and 3	100

15. Decibel Measurements

(fig. 1 and 2)

The lower meter scale (DECIBELS) is provided for making measurements in dbm or db.

When making measurements across an impedance of 600 ohms (*a* below), read the indication on the DECIBELS scale directly in dbm; when making measurements across an impedance other than 600 ohms (*b* below), apply the correction factor to obtain the dbm level (*c* below). Read the meter indication directly in db (*b* below) for comparison purposes when each measurement is made across the same value of impedance.

a. Measurement Across Impedance of 600 Ohms. To measure the level of a signal directly in dbm with this voltmeter (0 dbm equals 1 milliwatt of power across 600 ohms), the measurement must be made across an impedance of 600 ohms. Follow the procedures given in (1) through (7) below and read the meter indication directly in dbm.

- (1) Check to see that the meter needle indicates exactly 0 on the voltage scales (para 13a).
- (2) Connect the voltmeter to the ac power source (para 10c(2)).
- (3) Operate the power switch to the ON position, and allow a warmup period of approximately 5 minutes.
- (4) Operate the range selector switch to the desired position (para 12).
- (5) Connect the signal to be measured to the INPUT binding posts.
- (6) Note the meter indication on the DECIBELS scale. See the chart below to determine the value of the reading.

Range selector switch setting (DB)	When meter reading is between -12 and 0	When meter reading is between 0 and +2
	Subtract reading from value below and apply plus sign.	Add reading to value below and apply plus sign.
+50	50	50
+40	40	40
+30	30	30
+20	20	20
+10	10 ^a	10
	Add reading to value below and apply minus sign	
0	0	0

Range selector switch setting (DB)	When meter reading is between -12 and 0	When meter reading is between 0 and +2
		Subtract reading from value below and apply minus sign
-10	10	10
-20	20	20
-30	30	30
-40	40	40
-50	50	50
-60	60	60

^a Applies to a reading between -10 and 0 only. If the reading is between -10 and -12, subtract 10 and add a minus sign.

- (7) The level of the signal being measured is the algebraic sum of the meter indication and the db value of the range selector switch position. Examples are given in (*a*) and (*b*) below.

(*a*) If the indication on the DECIBELS scale is +2 and the range selector switch is in the +20 position, the level is +22 dbm.

(*b*) If the indication on the DECIBELS scale is +1.5 and the range selector switch is in the -40 position, the level is -38.5 dbm.

b. Measurement Across an Impedance Other than 600 Ohms. A db measurement made across an impedance other than 600 ohms is without respect to a reference level. Perform the procedures given in a(1) through (7) above and adapt the applicable procedure in (1) through (3) below.

Note. Since the measurement is made across an impedance other than 600 ohms, the level obtained (a(7) above) is now in db.

- (1) To obtain the reading in dbm, note the impedance across which the measurement is made and refer to the impedance correction graph (*c* below).
- (2) To obtain the difference in db between measurements made across equal impedances, algebraically subtract the levels being compared.
- (3) To obtain the difference in db between measurements made across different impedances, convert each measurement to dbm (*c* below) and algebraically subtract the levels being compared.

c. *Impedance Correction Graph* (fig. 6). When a measurement is made across an impedance other than 600 ohms, the level in dbm may be obtained by using the impedance correction graph.

- (1) Perform the steps given in a(1) through (7) above.
- (2) On the impedance correction graph, find the correction factor for the impedance across which the measurement is being made. This is accomplished by locating the impedance value at the base of the chart along the horizontal axis. From the impedance value point, extend a straight line vertically until it intersects the heavy diagonal line. From the intersection point of the heavy diagonal line, extend a line horizontally to the left to the scale value where the correction factor is read carefully.
- (3) The level of the signal in dbm is the algebraic sum of the value obtained in (1) above and the correction factor obtained from the graph. Examples are given in (a) and (b) below.

(a) If the indication on the DECIBELS scale is +2, the range selector switch is in the +30 position, and the measurement is made across an impedance of 90 ohms, the corrected level is 40 dbm and is obtained as follows:

$$\begin{array}{r}
 + 2 \text{ (meter indication)} \\
 \underline{+30} \text{ (range selector switch position)} \\
 +32 \text{ (sum)} \\
 \underline{+8} \text{ (correction factor from graph)} \\
 +40 \text{ dbm}
 \end{array}$$

(b) For the same conditions as given in (a) above, except that the measurement is made across an impedance of 60,000 ohms, the corrected level is +12 dbm and is obtained as follows:

$$\begin{array}{r}
 + 2 \text{ (meter indication)} \\
 \underline{+30} \text{ (range selector switch position)} \\
 +32 \text{ (sum)} \\
 \underline{-20} \text{ (correction factor from graph)} \\
 +12 \text{ dbm}
 \end{array}$$

16. Amplifier Operation

(fig. 1 and 2)

a. The amplifier section of the voltmeter may be used to amplify signals in the frequency range of 10 cps to 4 mcs for other applications. With full-scale meter deflection, the open-circuit output of the amplifier is approximately 0.15-volt rms on all ranges. The impedance looking into the OUTPUT binding posts is approximately 50 ohms.

Caution: When using the voltmeter as an amplifier do not apply more than twice the value indicated by the range selector switch. Equipment damage will result.

b. When the voltmeter is used as an amplifier, it will safely accommodate an input voltage of approximately twice the value indicated by the range selector switch. For example, with the range selector switch in the .001 position, an input voltage of up to 0.002 volt may be applied.

c. Maximum gain from the amplifier is obtained on the .001 VOLTS range. This is due to the 10-db loss per step inserted by the range selector switch as it is operated in a clockwise direction. Amplification may also be obtained on the .003, .01, .03, and .1 VOLTS ranges.

d. To obtain maximum gain from the amplifier, follow the procedures in (1) through (5) below:

- (1) Connect the voltmeter to the ac power source (para 10c(2)).
- (2) Operate the power switch to the ON position, and allow a warmup period of approximately 5 minutes.
- (3) Operate the range selector switch to the .001 position.
- (4) Connect the equipment which is to receive the amplified signal to the OUTPUT binding posts.
- (5) Connect the signal to be amplified to the INPUT binding posts.

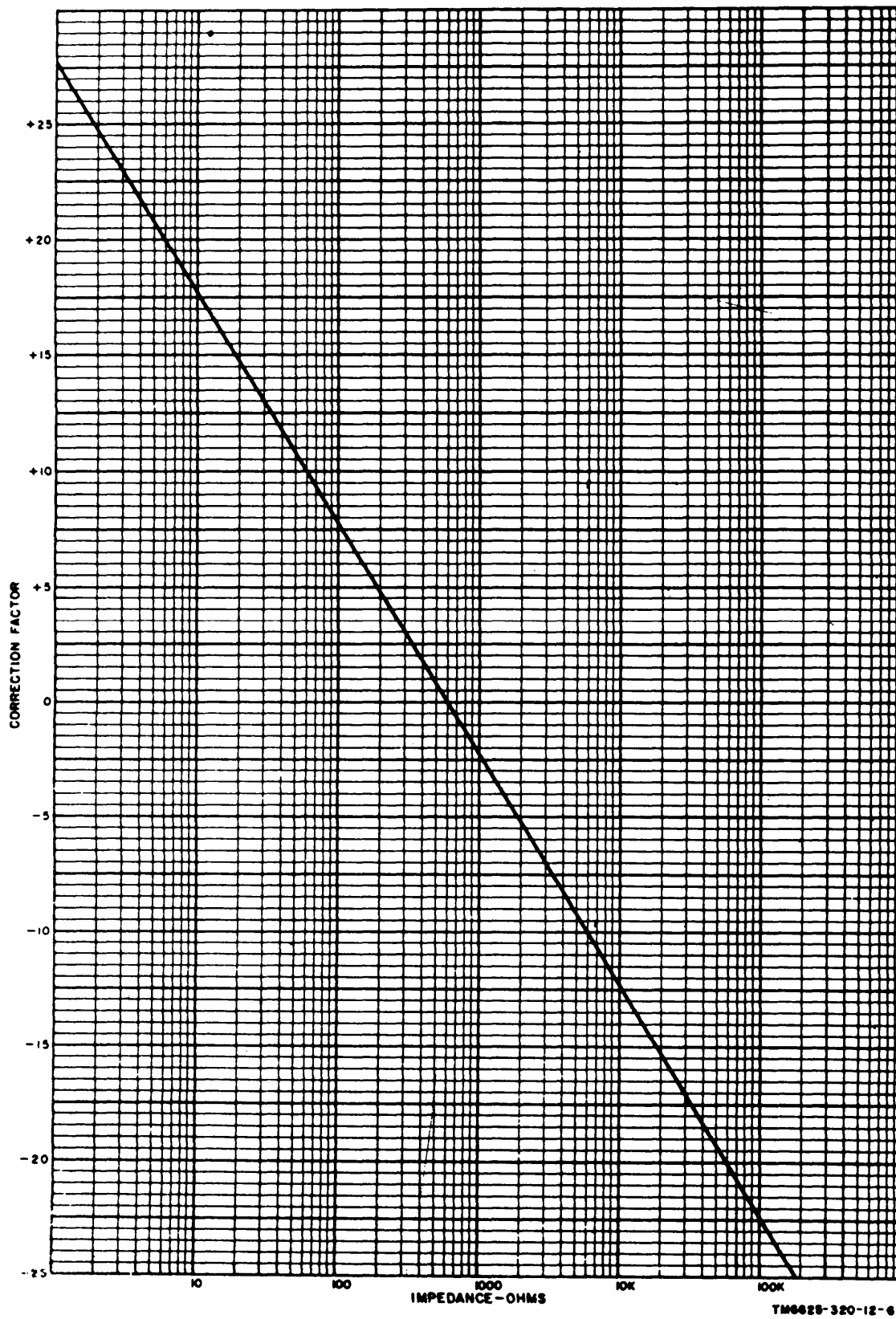

Figure 6. Impedance correction graph.

CHAPTER 4

OPERATOR'S MAINTENANCE INSTRUCTIONS

17. Scope of Operator's Maintenance

The following is a list of maintenance duties normally performed by the operator. These procedures do not require special tools or test equipment.

- a. Preventive maintenance (para 18).
- b. Visual inspection (para 19).
- c. Operational checklist (para 20).
- d. Replacement of defective power indicator lamp (para 21a).
- e. Replacement of defective fuse (para 21b).
- f. Replacement and test of power supply tubes (para 21c).
- g. Removal of panel-chassis (para 21d).

18. Preventive Maintenance

a. *DA Form 11-266.* DA Form 11-266 (fig. 7 and 8) is a preventive maintenance checklist to be used by the operator. Items not applicable are lined or crossed out in the figures. References in the ITEM block in the figures are to paragraphs that contain additional maintenance information pertinent to the particular item. Instructions for use of the form appear on the form.

b. *Items.* The information shown in the chart below supplements DA Form 11-266. The item numbers correspond to the ITEM numbers on the form.

Item	Maintenance procedures
1	Use a clean cloth to remove dust, dirt, moisture, and grease from the case and front panel. If necessary, wet the cloth with Cleaning Compound (Federal stock No. 7930-395-9542) and then wipe the parts with a dry, clean cloth.
3	The range selector switch should work smoothly

Action	Normal indication	Corrective measure
Turn power switch to ON position.	Power indicator lamp lights.	Check fuse (para 21b). Check incandescent lamp (para 21a). Check connectors on power cable.

Item	Maintenance procedures
	and should not bind. Apply several drops of cleaning compound so that it will run down the shaft to eliminate binding.

Warning: Cleaning compound is flammable and its fumes are toxic. Do not use it near a flame; provide adequate ventilation.

19. Visual Inspection

a. When the voltmeter fails to perform properly, turn off the power and check all the items listed below. *Do not check any item with the power on.*

- (1) Wrong setting of range selector switch.
- (2) Power cable disconnected or poorly connected.
- (3) Burned-out fuse (usually indicates some other fault) (para 21b).
- (4) Meter not zeroed (para 13a(1)). Pointer bent.

b. If the above checks do not locate the trouble, proceed to the operational checklist (para 20).

20. Operational Checklist

a. *General.* The operational checklist will help the operator to locate trouble quickly. The corrective measures are used to repair this trouble. If the measures suggested do not restore normal equipment performance, troubleshooting is required by higher echelon. Note on the repair tag what corrective measures were taken and how the equipment performed at the time of failure.

b. *Procedure.* Place the test set in operation (para 14). After the equipment has had time to warm up, perform the steps in *c* below in the order given. Observe the equipment and perform any corrective measures necessary.

c. *Checklist.*

Action	Normal indication	Corrective measure
With power on, measure a known voltage with range selector switch in proper position.	Meter will indicate the correct voltage.	Check tubes V6 through V9 (para 21c). See paragraph 21d for removal of panel-chassis.

21. Repairs

a. *Replacement of Power Indicator Lamp* (fig. 1 and 2).

- (1) Unscrew (counterclockwise) the indicating light lens and remove it to expose the lamp (DS-1).
- (2) Press in on the incandescent lamp and turn it counterclockwise to unlock.
- (3) Remove the defective lamp and replace it with a new one. Push the lamp in and twist it clockwise to lock.
- (4) Replace the indicating light lens by screwing it on clockwise.

b. *Replacement of Fuse* (fig. 9).

Caution: Do not use a fuse rated above the specified value (para 10c(2)). Damage to the equipment may result.

- (1) Turn the cap, electrical (fuseholder cap) counterclockwise to unlock.
- (2) Pull out the fuseholder cap with the defective fuse. Remove the defective fuse and replace it with a new one.
- (3) Insert the fuseholder cap, with the new fuse, into the fuseholder. Press in on the fuseholder cap and turn it clockwise to lock.

c. *Tube Testing and Replacement* (fig. 10). If tube failure is suspected (V6, V7, V8, or V9), use the applicable procedure below to remove, check, and replace tubes. Replacement of tubes V1-V5 should be made by higher echelon only.

Caution: Do not rock or rotate a tube when removing it from a socket. Pull it straight out with a tube puller.

- (1) *Removal and replacement of tube.*
 - (a) *Tubes with retaining springs.* Push the tube-retaining spring away and down from the top of the tube so that it swings on its jointed hinge. Return the spring to the original position after the new tube is inserted.
 - (b) *Tubes with shields.* To remove the tube shield, press it down and turn

it counterclockwise to unlock. Remove the tube shield. After replacing the tube, replace the tube shield by pressing the shield down and turning it clockwise until it locks into place.

- (2) *Use of tube tester.* Remove and test one tube at a time. Discard a tube only if its defect is obvious or if the tube tester shows it to be defective. Do not discard a tube that tests at or near its minimum test limit on the tube tester. Put back the original tube, or insert a new one if required, before testing the next one.
- (3) *Tube substitution method.* Replace a suspected tube with a new tube. If the equipment still does not work, remove the new tube and put back the original tube. Repeat this procedure with each suspected tube until the defective tube is located.
- (4) *Preferred-type tube.* A preferred-type electron tube type OB2WA is used as a direct replacement for nonpreferred-type OB2. When replacement of an OB2 type tube is necessary, replace it with an OB2WA. Do not substitute an OB2 for an OB2WA.

d. *Removal and Replacement of Panel-chassis.*

Warning: Disconnect the power cable from the power source before removing the panel-chassis from the case. After power to the voltmeter is disconnected, some capacitors may retain a dangerous voltage.

- (1) *Panel-chassis removal.*
 - (a) *ME-30A/U and ME-30C/U.* Remove the two screws at the rear of the voltmeter and slide the case to the rear to remove the panel-chassis assembly.
 - (b) *ME-30B/U.* Remove the four screws and rubber grommets on the bottom of the voltmeter and slide the

**MAINTENANCE CHECK LIST FOR SIGNAL EQUIPMENT
TEST EQUIPMENT
(AR 750-625)**

EQUIPMENT NOMENCLATURE

VOLTMETER, METER ME 30A/U

EQUIPMENT SERIAL NUMBER

274

INSTRUCTIONS

This form may be used for a period of one month by using the correct dates and weeks of the month. It is to be used as a Preventive Maintenance check list for Signal equipment in actual use, or for a check on equipment prior to issue.

1. For detailed Preventive Maintenance instructions see:
 - a. The Technical Manual (in TM 11 series) for the equipment.
(See DA Pamphlet Number 310-4)
 - b. The Supply Bulletin (SB 11-100 series) for the equipment.
(See DA Pamphlet Number 310-4)
 - c. The Department of the Army Lubrication Order.
(See DA Pamphlet Number 310-4)

2. The following action will be taken by either the Communications Officer/Chief for 1st echelon, or the Inspector for higher echelon
 - a. Enter Equipment Nomenclature and Serial Number.
 - b. Strike out items that do not apply to the equipment.

3. Operator/inspector will enter in the columns entitled **CONDITION**, on the proper line, a notation regarding the condition, using symbols specified under **LEGEND**.

4. After operator completes each daily inspection he will initial over the appropriate dates under "Daily Condition for Month", then return form to his supervisor.

FOLD

TYPE OF INSPECTION

OPER- ATOR	2/3 ECH- ELON	DATE	SIGNATURE
✓		1 July '60	J. P. Mason
✓		7 July '60	G. J. Lee

Figure 7. DA Form 11-266, pages 1 and 4.

LEGEND for marking conditions: Satisfactory, ✓ Adjustment, Repair or Replacement required, X. Defect corrected, (X)						DAILY CONDITION FOR MONTH OF JULY '60																								
NO.	DAILY ITEM	17 18 19 20 21 22 23 24 25 26 27 28 29 30 31													2D 3D ECH- ELON															
		[Diagonal lines across days 17-31]																												
1	CLEAN DIRT AND MOISTURE FROM EXPOSED SURFACES OF MOUNTS, CASES, CABINETS, CONTROL PANELS, INTERCONNECTING PLUGS, CABLES, HEADS, METER WINDOWS, ETC. PARA 18b	✓	✓	✓	✓	✓	✓	✓	✓	✓	✓	✓	✓	✓	✓	✓	✓	✓	✓	✓	✓	✓	✓	✓	✓	✓	✓			
2	INSPECT FOR LOOSENESS OF EXTERIOR ITEMS SUCH AS SWITCHES, KNOBS, JACKS, CONNECTORS AND PILOT LIGHTS. PARA 18b	✓	✓	✓	✓	(X)	✓	✓	✓	✓	✓	✓	✓	✓	✓	✓	✓	✓	✓	✓	✓	✓	✓	✓	✓	✓	✓	✓		
3	INSPECT CONTROLS FOR BINDING, SCRAPING, TAP CONTROLS LIGHTLY FOR CUT-OUT DUE TO LOOSE CONTACTS. PARA 18b	✓	✓	✓	✓	✓	✓	✓	✓	✓	✓	✓	✓	✓	✓	✓	✓	✓	✓	✓	✓	✓	✓	✓	✓	✓	✓	✓		
4	DURING OPERATION BE ALERT FOR ANY UNUSUAL PERFORMANCE OR CONDITION. PARA 14 THRU 16	✓	✓	✓	✓	✓	✓	✓	✓	✓	✓	✓	✓	✓	✓	✓	✓	✓	✓	✓	✓	✓	✓	✓	✓	✓	✓	✓		
WEEKLY		CONDITION EACH WEEK					2D 3D ECH	ADDITIONAL ITEMS FOR 2D AND 3D ECHELON INSPECTIONS													CONDITION									
5	INSPECT WIRING, CABLES, WIRE AND CABLE BUNDLES FOR BREAKS, CUTS, KINKS, DEGRADATION, STRAIN AND FRAYING.	✓																												
6	INSPECT GUMMS AND LEATHER ITEMS FOR SWELLING, CRACKING, TEARS, BROKEN STRIPS AND SPLIT FASTENERS.																													
7	HAND CHECK FOR LOOSENESS OF EXTERIOR ITEMS SUCH AS HANDLES, LATCHES, HOODS.	✓																												
8	INSPECT FOR OIL LUBRICATION IN ACCORDANCE WITH RELIABLE LUBRICATION SCHEDULE.																													
9	INSPECT FOR OIL LEAKS FROM OIL DOTS, HOLES, TERMINALS AND LEAKAGE.																													
10	INSPECT EXPOSED METAL SURFACES FOR RUST AND CORROSION.	✓																												
11	INSPECT METERS FOR DAMAGED GLASS AND CASES.	✓																												
ADDITIONAL ITEMS FOR 2D AND 3D ECHELON INSPECTIONS							CONDITION	[Large X across entire section]																						
12	INSPECT SEATING OF READILY ACCESSIBLE ITEMS OF A PLUG-OUT NATURE: CRYSTALS, TUBES, CONNECTORS, PLUG-IN COILS, LAMPS, ETC. DO NOT REMOVE, ROCK OR TWIST TO INSPECT. USE ONLY A DIRECT PRESSURE TO INSURE THE ITEM IS FULLY SEATED.																													
13	INSPECT FOR CLEANLINESS AND TIGHTNESS OF SUCH ITEMS AS HOOD MOUNTS, ANTENNA, ANTENNA MOUNTS AND WAVE GUIDES.																													
14	INSPECT RELAY AND CIRCUIT BREAKER ASSEMBLIES FOR DIRT, CORROSION, WORN OR BURNED CONTACTS.																													
								IF DEFICIENCIES NOTED ARE NOT CORRECTED DURING THE INSPECTION, INDICATE ACTION TAKEN FOR CORRECTION. (Continue on page 4, if more space is needed)																						

Figure 8. DA Form 11-266, pages 2 and 3, as used by the operator.

case forward to remove the panel-chassis assembly.

(2) *Panel-chassis replacement.*

(a) *ME-30A/U and ME-30C/U.* Pull the power cable through the opening at the rear of the case and slide

the case onto the panel-chassis assembly. Replace the two screws ((1)(a) above).

(b) *ME-30B/U.* Slide the case onto the panel-chassis assembly and replace the rubber grommets and four screws ((1)(b) above).

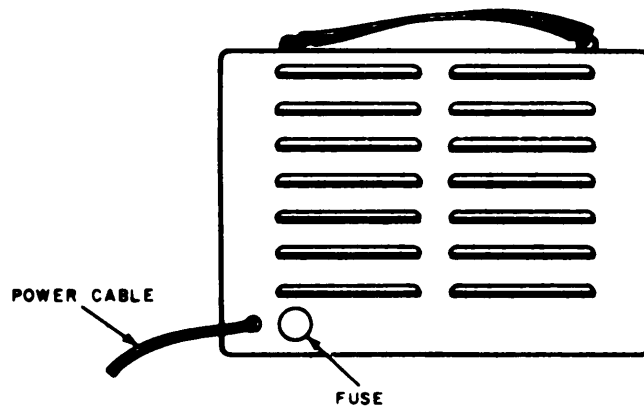

A. VOLTMETER, ELECTRONIC ME-30B/U, REAR VIEW.

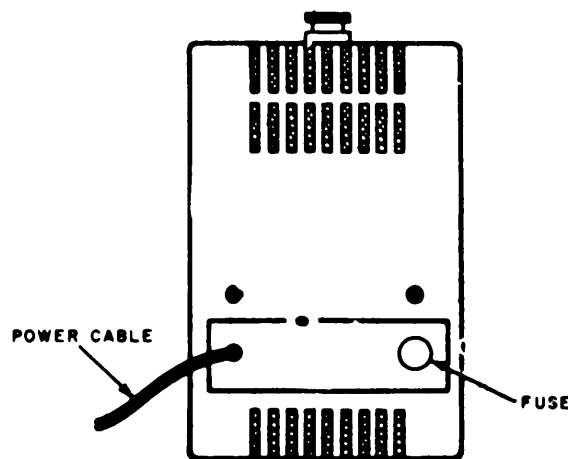

B. VOLTMETER, METER ME-30A/U,
AND
VOLTMETER, ELECTRONIC ME-30C/U, REAR VIEW.

TM6625-380-12-6

Figure 9. Fuse location diagram.

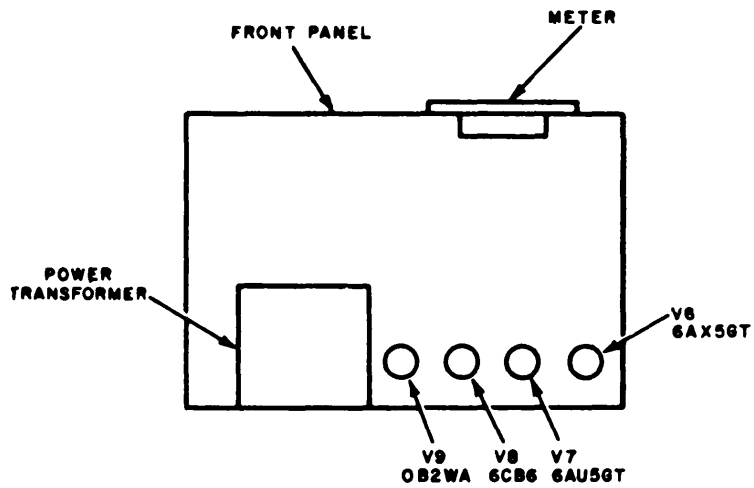

A. VOLTMETER, ELECTRONIC ME-30B/U, TOP OF CHASSIS.

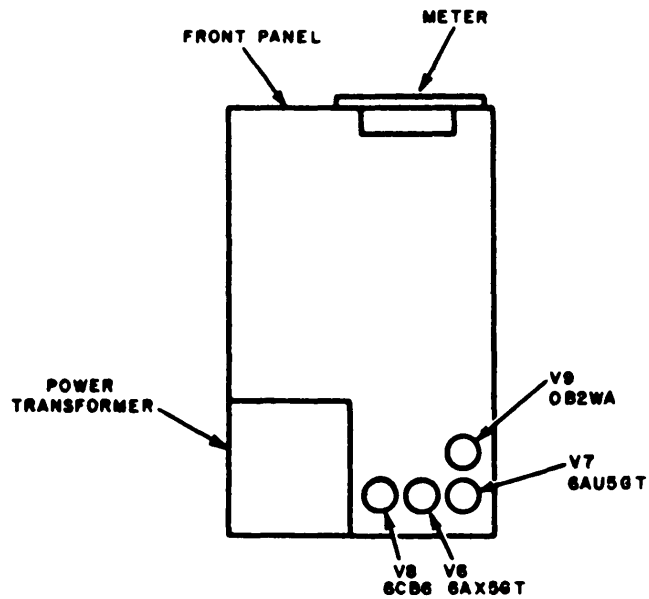

B. VOLTMETER, METER ME-30A/U,
AND
VOLTMETER, ELECTRONIC ME-30C/U, RIGHT SIDE OF CHASSIS.
TM6625-320-12-7

Figure 10. Tube location diagram.

CHAPTER 5

ORGANIZATIONAL MAINTENANCE

22. Scope of Organizational Maintenance

a. This chapter contains instructions for second echelon maintenance of Voltmeter, Meter ME-30A/U and Voltmeters, Electronic ME-30B/U and ME-30C/U.

b. Second echelon maintenance includes:

- (1) Preventive maintenance (para 23).
- (2) Visual inspection (para 19).
- (3) Operational checklist (para 20).
- (4) Replacement of defective power indicator lamp (para 21a).
- (5) Replacement of defective fuse (para 21 b).
- (6) Replacement and test of power supply tubes (para 21c).
- (7) Removal of panel-chassis (para 21d).

23. Organizational Preventive Maintenance

a. DA Form 11-266. DA Form 11-266 (fig. 11) is a preventive maintenance checklist to be used by the second echelon repairman. Items not applicable to the equipment are lined out on the figure. References to the ITEM block in the figure are to paragraphs that contain additional maintenance information pertinent to the particular item. Addi-

tional preventive maintenance information concerning items 1 and 3 on DA Form 11-266 will be found in paragraph 18b. Instruction for use of the form appear on the form (fig. 7).

b. Items. The information shown in the chart below is supplementary to DA Form 11-266. The item numbers correspond to the ITEM numbers on the form.

Warning: After power is disconnected, some capacitors may retain dangerous voltages. Before touching exposed electrical parts, short circuit the parts to ground. When maintenance is completed, replace the equipment in its case, reconnect the power, and check for satisfactory operation.

Item	Maintenance procedure
12	Check to see that the tube retaining springs hold the tubes firmly and straight in the tube sockets.
20	Use a clean, dry, lint-free cloth to remove dust and dirt from the internal components. If necessary, wet the cloth with cleaning compound (para 18b) and then wipe the components with a clean dry cloth.

Note. If, during the inspection of the voltmeter component, defects are noted requiring repair or replacement bigger echelon maintenance is required.

LEGEND for marking conditions: Satisfactory, ✓. Adjustment, Repair or Replacement required, X. Defect corrected, (X).						DAILY CONDITION FOR MONTH OF JULY '60													
NO.	DAILY ITEM	1 2 3 4 5 6 7 8 9 10 11 12 13 14 15 16 17 18 19 20														2D 3D ECH- ELON			
		/																	
	1. CLEAN DIRT AND MOISTURE FROM EXPOSED SURFACES OF WINDSHIELD , CASES, CABINETS, CONTROL PANELS, INTER-CONNECTING PLUGS, CABLES, HEADERS, METER WINDOWS, ETC. PARA 18b	/														✓			
	2. INSPECT FOR LOOSENESS OF EXTERIOR ITEMS SUCH AS SWITCHES, KNOBS, JACKS , CONNECTORS AND PILOT LIGHTS. PARA 18b	/														✓			
	3. INSPECT CONTROLS FOR BINDING, SCRAPING. TAP CONTROLS LIGHTLY FOR CUT-OUT DUE TO LOOSE CONTACTS. PARA 18b	/														✓			
	4. DURING OPERATION BE ALERT FOR ANY UNUSUAL PERFORMANCE OR CONDITION. PARA 14 THRU 16	/														✓			
WEEKLY		CONDITION EACH WEEK					2D 3D ECH	ADDITIONAL ITEMS FOR 2D AND 3D ECHELON INSPECTIONS		CONDITION									
	5. INSPECT WIRE CABLES, WIRE AND SHIELD WINDING FOR BREAKS, CUTS, KINKS, DEGRADATION, STRAIN AND FRAYING.	1ST	2D	3D	4TH	5TH	✓	19. INSPECT RESISTORS, BUSHINGS, INSULATORS FOR CRACKS, CHIPPING, BLISTERING, DISCOLORATION AND MOISTURE.	✓										
	6. INSPECT CANVAS AND LEATHER ITEMS FOR FUNGUS, FRAYING, TEARS, CRACKS, BURNS AND SHARP EDGES.							20. INSPECT GROUND CONNECTORS FOR SNUG FIT AND GOOD CONTACTS.	✓										
	7. HAND CHECK FOR LOOSENESS OF EXTERIOR ITEMS SUCH AS HANDLES, WASHERS , KNIBS .						✓	21. INSPECT TERMINAL BUSHINGS FOR DIRT AND MOISTURE.											
	8. INSPECT FOR LUBRICATION IN ADDITIONAL WHERE APPLICABLE AS LUBRICATION ORDER.							22. INSPECT SCREWTYPE TERMINALS OF TRANSFORMERS, FIXED CAPACITORS, RESISTORS, CHOKES, POTENTIOMETERS AND RHEOSTATS FOR CORROSION, DIRT AND LOOSE CONTACTS.	✓										
	9. INSPECT FOR ELECTRICAL RESISTANCE, GOOD TERMINALS AND LEAKAGE.							23. CLEAN AND TIGHTEN SWITCHES, BLOWERS, RELAY CASES, CLEAN INTERIOR OF CHASSIS AND CABINETS. PARA 23b	(+)										
	10. INSPECT EXPOSED METAL SURFACES FOR RUST AND CORROSION.						✓	24. INSPECT GENERATORS, MOTORS AND EXHAUSTORS FOR BRUSH WEAR, SPRING TENSION, ARMOR AND COMMUTATOR WEAR.											
	11. INSPECT METERS FOR DAMAGED GLASS AND CASES.						✓	25. INSPECT TERMINAL BLOCKS FOR LOOSE CONNECTIONS, CRACKS AND BREAKS.	✓										
	12. INSPECT SEATING OF READILY ACCESSIBLE ITEMS OF A PLUCK-OUT NATURE: CONNECTOR FUSES, CONNECTORS , PLUGS IN COILS, LAMPS, ETC. DO NOT REMOVE, ROCK OR TWIST TO INSPECT. USE ONLY A DIRECT PRESSURE TO INSURE THE ITEM IS FULLY SEATED. PARA 23b						✓	26. INSPECT CASES AND BUSHINGS FOR WEAR AND DAMAGE.											
	13. INSPECT FOR BUSHINGS AND TIGHTNESS OF BUSHINGS AS SHOWN IN MANUAL, AND MANUAL MOUNTS AND WAVE GUIDES.							27. INSPECT CANVAS AND LEATHER ITEMS FOR FUNGUS, FRAYING, TEARS, CRACKS, BURNS AND SHARP EDGES.											
	14. INSPECT RELAY AND CIRCUIT BREAKER ASSEMBLIES FOR DIRT, CORROSION, WEAR OR BURNED CONTACTS.							28. INSPECT OPERATOR CONTROLS REMOVE ALL CAPTIONS.											
								IF DEFICIENCIES NOTED ARE NOT CORRECTED DURING THE INSPECTION, INDICATE ACTION TAKEN FOR CORRECTION. (Continue on page 4, if more space is needed)											

Figure 11. DA Form 11-266, pages 2 and 3 as used by second echelon.

CHAPTER 6
SHIPMENT, LIMITED STORAGE, AND DEMOLITION
TO PREVENT ENEMY USE

Section I. SHIPMENT AND LIMITED STORAGE

24. Removal from Service

To prepare the voltmeter for shipment or limited storage, follow the steps below.

- a. Operate the power switch away from the ON position and remove the power plug from the ac power source.
- b. Wind the power cable into a coil approximately 6 inches in diameter and secure it with masking tape.
- c. Remove any test leads connected to the binding posts.
- d. Tighten the knurled nuts on the INPUT and OUTPUT binding posts to prevent loss.
- e. Attach a tag to the handle of the voltmeter, indicating the voltage for which the primary winding of the power transformer is wired.

25. Repackaging for Shipment or Limited Storage

(fig. 12)

The exact procedure for repackaging depends on the material available and the con-

ditions under which the equipment is to be shipped or stored. Adapt the procedures outlined below whenever circumstances permit. The information concerning the original packaging (para 9) will also be helpful.

a. *Material Requirements.* The following estimated materials are required for packaging. For stock numbers of materials, consult SB 38-100.

(1) *Materials.*

Material	Quantity
Fiberboard, corrugated	40 sq ft.
Tape, paper, gummed	12 ft.
Barrier material (waterproof paper)	45 sq ft.
Tape, pressure sensitive	15 ft.
Strapping, flat steel, 5/8" x 0.020" (strapping seals are required).	80 ft.
Wooden shipping box	1 ea.

(2) *Dimensional data.*

Box No.	Voltmeter type No.	Lg (in.)	Inside dimensions W (in.)	D (in.)	Outside s (cu ft)	Lumber s (board ft)	Packed s wt (lb)
1	ME-30A/U	31 3/4	18 3/4	12 1/2	6.9	20.2	140
1	ME-30B/U	24 3/4	19 3/4	11 1/2	5.5	20.2	136
1	ME-30C/U	31 3/4	18 3/4	12 1/2	6.9	20.2	140

*Based on four voltmeters in one wooden box.

b. *Packaging.* Package the voltmeters as follows:

- (1) Package the technical manuals within a close-fitting bag fabricated of waterproof paper. Seal the bag securely with pressure sensitive tape.
- (2) Spare parts, fuses, lamps, and tubes are cushioned by wrapping with fiberboard. Secure the cushioning with gummed paper tape. Overwrap the cushioned items with waterproof paper. Secure with pressure sensitive tape.

- (3) The voltmeters are cushioned by wrapping with fiberboard. Secure the cushioning with gummed paper tape. Overwrap the cushioned voltmeter with waterproof paper. Secure with pressure sensitive tape.

c. *Packing.*

- (1) Place four each voltmeters within a nailed wooden box.
- (2) Strap each nailed wooden box if packing for intertheater shipment.

Section II. DEMOLITION OF MATERIEL TO PREVENT ENEMY USE

26. Authority for Demolition

The destruction procedures outlined in paragraph 27 will be used to prevent enemy use of the equipment. Demolition of the voltmeter will be accomplished only upon the order of the commander.

27. Methods of Destruction

Use any or all of the following methods to destroy equipment:

a. Smash. Use sledges, axes, handaxes, pickaxes, hammers, or crowbars to smash the controls, tubes, switches, capacitors, transformers, and meter.

b. Cut. Use axes, handaxes, or machetes to cut the power cable.

c. Burn. Use gasoline, kerosene, oil, flame-throwers, or incendiary grenades to burn cords and technical manuals.

Warning: Be extremely careful with explosives and incendiary devices. Use these items only when the need is urgent.

d. Explode. Use firearms, grenades, or TNT if explosives are necessary.

e. Dispose. Bury or scatter the destroyed parts in slit trenches, foxholes, or throw them into nearby waterways.

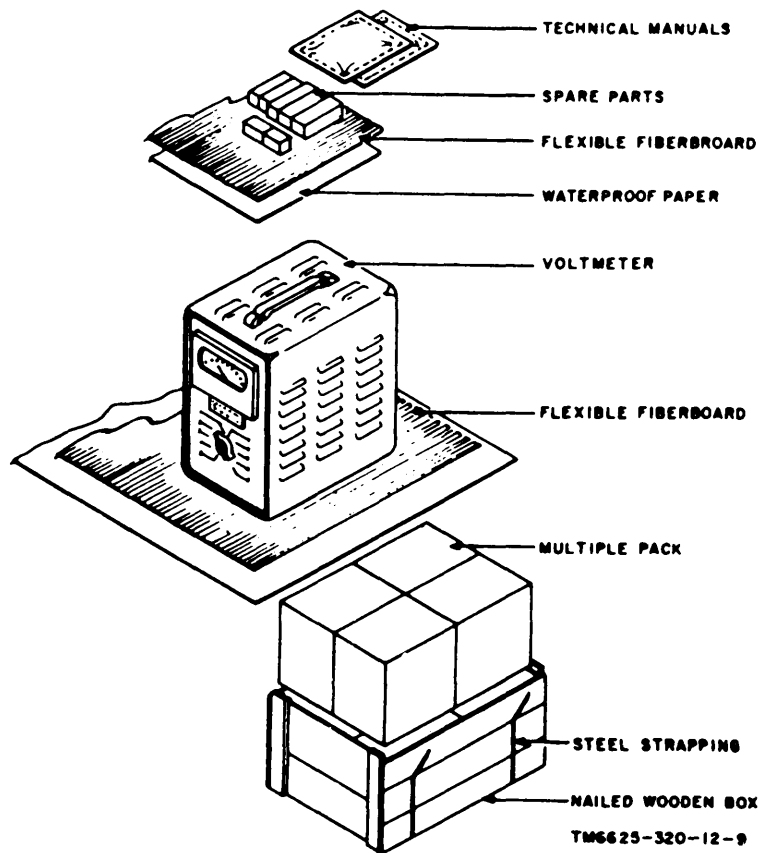

Figure 12. Repackaging diagram.

APPENDIX

REFERENCES

Following is a list of applicable references available to the operator of Voltmeter, Meter ME-30A/U and Voltmeters, Electronic ME-30B/U and ME-30C/U:

SB 38-100	Preservation, Packaging, and Packing Materials, Supplies, and Equipment used in the Army.
TB SIG 225	Radioactive Electron Tube Handling.
TM 11-6625-320-12P	Operator's and Organizational Maintenance Repair Parts and Special Tools Lists and Maintenance Allocation Chart; Voltmeter, Meter ME-30A/U, Voltmeter, Electronic ME-30B/U and ME-30C/U.

GLOSSARY

db — The unit selected with which to compare any two values of power is the bel. If the two values of power are P_1 and P_2 , then by definition

$$\text{bels} = \text{Log}_{10} \frac{P_2}{P_1}$$

This unit is too large for general use. It is more convenient to use the decibel (*db*) which is one-tenth of a bel or

$$db = 10 \text{Log}_{10} \frac{P_2}{P_1}$$

Both of these units are relative measurements and do not specify any definite amount of power. They are the logarithmic ratio between any two values of power.

dbm — A power level in *db* can also be expressed in reference to a standard level of power. As used with this voltmeter, the standard level is 1 milliwatt. When used in this manner, the result is expressed as *dbm* (decibel with reference to 1 milliwatt).

$$dbm = 10 \text{Log}_{10} \frac{P_2}{0.001 \text{ W}} \text{ where } P_2 = \frac{E^2}{R}$$

Dbm represents a logarithmic rate of a specific amount of power.

rms - *Rms* literally means root mean square. The rms value of a sine wave is equal to 0.707 times the peak value.

Average value of ac voltage — The average value of a sine wave is equal to 0.637 times the peak value.

Impedance - Impedance is the ratio of the potential difference between the terminals under consideration to the resulting current in an ac circuit. It indicates the degree of opposition to current flow.

Broadband amplifier - An ordinary amplifier tends to lose its amplification ability when the frequencies of the signals being amplified are extremely low or high. A broadband amplifier is one which overcomes this failing through the use of added frequency compensating networks. The amplification of signals will be constant over a wide frequency range.

By Order of *Wilber M. Brucker*, Secretary of the Army:

L. L. LEMNITZER,
General, United States Army,
Chief of Staff.

Official:

R. V. LEE,
Major General, United States Army,
The Adjutant General.

Distribution:

Active Army:

To be distributed in accordance with DA Form 12-7 requirements for TM 11 Series (UNCL) plus the following additional formula:

USASA (1)	11-17
CNGB (1)	11-18
Def Atomic Spt Agcy (5)	11-38
Tech Stf, DA (1) except	11-39
CSigO (18)	11-55
USA Abn & Elct Bd (1)	11-56
USA ATB (1)	11-57
US ARADCOM (2)	11-95
US ARADCOM Rgn (2)	11-97
MDW (1)	11-117
Seventh, US Army (5)	11-155
EUSA (5)	11-500 (AA-AE)
Corps (2)	11-557
JBUSMC (2)	11-587
Units org under the fol TOE: (2 copies each)	11-592
7	11-597
11-5	17
11-6	32-61
11-7	32-56
11-16	39-61
11-16	

NC: None

USAR: None.

For explanation of abbreviations used, see AR 320-50.

